



ASTON MARTIN

Virage

Aston Martin Owner's Club

An invitation to join the Aston Martin Owner's Club

The sporting spirit of the 1930s exists today in one of the world's most exclusive car clubs. Enthusiasts in nearly 60 countries are united by an interest in iconic cars with an enviable pedigree. Enjoy the company of like-minded owners in a wide range of activities: social evenings, weekends away or motoring tours. Something more competitive? AMOC Concours are a benchmark for connoisseurs of fine motorcars. A need for speed? We organise track days, sprints and hill climbs as well as circuit racing in venues such as Silverstone, Goodwood and Lime Rock in the USA.



Mirroring Club activity, the Aston Martin Heritage Trust is an educational charity dedicated to the history of the marque from the earliest days almost a century ago. It shares the magnificent 15thC Oxfordshire barn which is the international headquarters, museum and archive. Why not log onto our website to discover more about these unique organisations, and enjoy a hearty welcome from us all.



The Aston Martin Owners Club
Drayton St. Leonard,
Wallingford,
Oxford,
England,
OX10 7BG

Telephone: +44 (0) 1865 400 400

Facsimile: +44 (0) 1865 400 200

E-Mail: hqstaff@amoc.org

Website: www.amoc.org



Introduction	1
Vehicle Security	2
Before Driving.....	3
Controls	4
Driving.....	5
Climate Control.....	6
Convertible Roof	7
Audio.....	8
Hands-Free Phone	9
Satellite Navigation	10
Maintenance	11
Specifications	12
Service	A
Aston Martin Warranty	B
Aston Martin Assistance.....	C
Alphabetical Index	D

Every effort has been made to make sure that the information provided in this Owner's Guide is accurate and up-to-date. However neither the manufacturer or the Dealer, by whom this Owner's Guide is supplied, will in any circumstances be held responsible for any inaccuracy or the consequences thereof. All rights reserved.

No part of this publication may be reproduced, stored in a retrieval system or transmitted, in any form, electronic, mechanical, photocopying, recording or other means without prior written permission from Aston Martin Lagonda Limited.

The manufacturer reserves the right to vary specifications without notice in accordance with its policy of continual product improvement.

Produced by the Technical Publications Department
ASTON MARTIN LAGONDA LIMITED
Banbury Road
Gaydon
WARWICK
Warwickshire
CV35 0DB
England
Telephone: (+44) 01926 644300
Fax: (+44) 01926 644733

Issue 1 – March 2011
Part Number – CG43-19A321-AA

Introduction

Welcome	1.2
Warnings, Cautions and Notes	1.3
Component Location	1.4
Vehicle Identification	1.4
Data Recording	1.5
Reporting Safety Defects	1.5
Vehicle Provenance.....	1.5



Welcome

Welcome to your new Aston Martin Virage.

This Owner's Guide, along with other publications included in your literature pack, provides information which will enhance your pleasure from owning and driving your Aston Martin.

This Owner's Guide has been designed to explain the vehicle's operation and to make the control of its systems easy to understand and operate. All new owners are recommended to carefully study the contents of this Owner's Guide prior to driving.

This Owner's Guide forms part of the essential vehicle equipment for homologation purposes and must stay with the vehicle at all times.

Aston Martin Franchise Dealers

A full list of Aston Martin Dealers worldwide, where sales and service are provided by companies with the facilities, knowledge and factory trained personnel can be found at:

www.astonmartin.com

Every effort is made to make sure that the information given in the dealer list is accurate and up-to-date. However changes amongst holders of the Aston Martin franchise can occur. Neither Aston Martin nor any listed Importer or Dealer shall in any circumstances be held liable for any inaccuracy, or the consequences thereof.

Dealers listed all aim to conform to Aston Martin standards of excellence in both sales and service. However, all vehicles sold as Aston Martins are required to meet local legislation requirements.

Should service be required in a country other than that in which this vehicle was originally purchased, every effort will be made to meet the owner's requirements, but the availability of certain parts may be affected by differences in vehicle and component specifications.

If the nearest Aston Martin Dealer is unable to help, contact Aston Martin directly:

Aston Martin Lagonda Limited

Banbury Road,

Gaydon,

WARWICK,

CV35 0DB

Telephone: (+44) (0)1926 644300

Facsimile: (+44) (0)1926 644733

Aston Martin Dealers are independent traders, they are not the Company's Agents, and therefore have no authority to bind the Company or to enter into any financial or other commitments on the Company's behalf.

Only Aston Martin Dealers are authorised to carry out warranty work.

Aston Martin Authorised Body Repairers

A full list of Aston Martin Authorised Body Repairers worldwide can be found at:

www.astonmartin.com

All Aston Martin Approved Body Repair centres have been assessed and audited to Aston Martin Body Repair Centre standards in either Category A or B.

Category A: Repairs to the bonded aluminium structure and all paint related and light structural damage.

Category B: All paint related and light structural damage.

Every effort is made to make sure that the information given in the Aston Martin Authorised Body Repairers list is accurate and up-to-date. However changes can occur. Neither Aston Martin nor any Aston Martin Authorised Body Repairer shall in any circumstances be held liable for any inaccuracy, or the consequences thereof.

Aston Martin Authorised Service Centres

A full list of Aston Martin Authorised Service Centres can be found at:
www.astonmartin.com

All Aston Martin Approved Service Centres have been assessed and audited to Aston Martin standards.

Every effort is made to make sure that the information given in the Aston Martin Authorised Service Centres list is accurate and up-to-date. However changes can occur. Neither Aston Martin nor any Aston Martin Authorised Service Centre shall in any circumstances be held liable for any inaccuracy, or the consequences thereof.

Warnings, Cautions and Notes

The following Warnings, Cautions and Notes are used within this Owner's Guide to call your attention to specific types of information.

Warnings

 **Warning: Provided to show procedures which must be followed precisely to help avoid the risk of personal injury.**

Cautions

 **Provided to show procedures which must be followed precisely to reduce the possibility of damage to your vehicle.**

Notes

 *Provided to show procedures which will help to avoid difficulties in the operation of your vehicle.*

Component Location

All directions for locating components are described as viewed from the driver's seat, i.e. the fuel filler flap shown on this diagram will be described as 'located at the rear left side of the vehicle'.

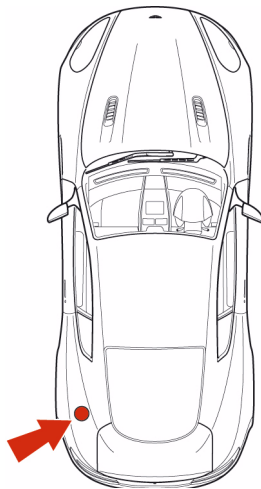

Vehicle Identification

The Vehicle Identification Number (VIN) is shown in the left side bottom corner of the windscreen.

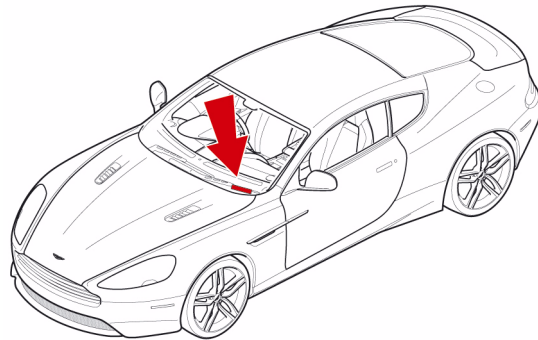

The VIN Plate, attached to the front subframe behind the engine bay front cross member (viewed from above), is model and market dependent:

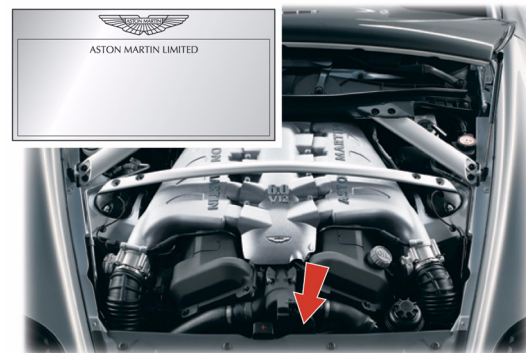

Data Recording

Computers in your vehicle are capable of recording detailed data, potentially including but not limited to information such as:

- The use of restraint systems including seat belts by the driver and passengers
- Information about the performance of various systems and modules in the vehicle
- Information related to engine, throttle, steering, brake or other system status

Any of this information could potentially include information regarding how the driver operates the vehicle, potentially including but not limited to information regarding vehicle speed, brake, throttle application or steering input. This information may be stored under regular operation, in a crash or near crash event.

This information may be read out and used by:

- Aston Martin
- Service and repair facilities
- Law enforcement or government agencies
- Others who may assert a right or obtain your consent to know such information

Reporting Safety Defects

If you believe that your vehicle has a safety defect which could cause a crash or could cause injury or death, you should immediately inform your Aston Martin Dealer or the manufacturers Service Operations Department at the address shown.

Aston Martin Lagonda Limited
Service Operations Department
Banbury Road
Gaydon
WARWICK
CV35 0DB
England

Telephone:

(International) ++44 1926 644700
(United Kingdom) 01926 644700
Facsimile (+44) 1926 644733

Vehicle Provenance

Model:

e.g. Manual, Automatic

Body Colour:

Interior Colour:

Fascia Colour:

Vehicle Identification Number:

As on the VIN plate

First Owner:

Selling Dealer

Delivery Date

Third Owner:

Selling Dealer

Delivery Date

Fifth Owner:

Selling Dealer

Delivery Date

Second Owner:

Selling Dealer

Delivery Date

Fourth Owner:

Selling Dealer

Delivery Date

Sixth Owner:

Selling Dealer

Delivery Date

Vehicle Security

Introduction	2.2	Deadlocking.....	2.8
Aston Martin Tracking	2.2	Automatic Lock.....	2.9
Emotion Control Unit.....	2.3	Approach Light.....	2.9
Emergency Key.....	2.4	Homesafe	2.10
Unlocking and Opening.....	2.4	Alarm	2.10
Locking	2.5	Reduced Guard.....	2.11
Master Locks	2.6	Passive Anti-Theft System	2.12
Boot Lid	2.7	Garage Door Opener	2.13
		Personalisation	2.16

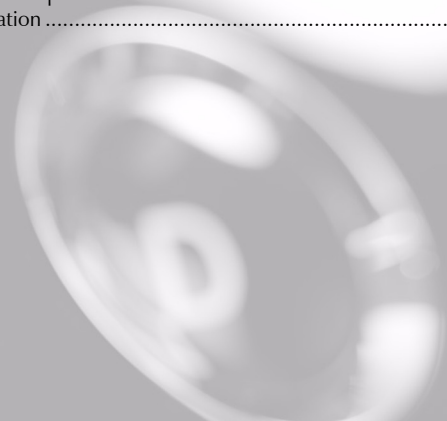

Introduction

This vehicle is protected by electronic security system which includes:

- Remote arm and disarm
- Perimeter sensing
- Remote door, boot lid, fuel flap release lock and unlock
- Guard reduction mode
- Alarm siren with battery backup¹
- Random code encryption to prevent electronic scanning or grabbing of the vehicle key identity code
- Interior movement sensor²
- Tilt Sensor².

Vehicle protection is enhanced by a Passive Anti-Theft System (PATS) which provides engine immobilisation if the wrong vehicle key is used.

When the security system is armed, any attempt to forcibly open a door, the boot lid or the bonnet will result in full alarm operation.

Garage Door Opener

Option

As a security precaution make sure that all programming is erased in the HomeLink system before selling this vehicle (Refer to 'Garage Door Opener', page 2.13).

Aston Martin Tracking

Option (Not Available in all Markets)

Standard - Mainland UK

The Aston Martin Tracking system works like an electronic homing device, transmitting a stolen vehicle's location.

The system, which is discretely installed in the vehicle, is an easy-to-use system that provides the following important features:

- Automatically arms the security system when the vehicle key is removed and you leave the vehicle
- Detects your presence (using a driver recognition tag) and automatically disarms the system when you return

 A convenient storage location for the driver recognition tag is provided in the armrest cubby box lid.

- Detects attempts to start the vehicle without you being there
- Detects attempts to tow or move the vehicle
- Detects attempts to tamper with the tracking system or disconnect the vehicle battery
- Transmits silent alarms to the 24-hour monitoring service
- Gives you priority access to police in more than 30 countries
- Meets all insurance requirements

¹. Markets where audible sirens are permitted.

². Option.

Refer to the Aston Martin Tracking User Guide for operating instructions.

Please consult your Aston Martin Dealer for details and subscription rates.

 Do not keep the Aston Martin Tracking User Guide in the vehicle otherwise you will not be able to refer to it if your vehicle is stolen.

Tag Warning

If the driver recognition tag is not in range of the vehicle tracking system the PATS symbol will continue to be ON after the vehicle has started. If this happens stop the engine, remove the vehicle key from the ignition control and check the location of the recognition tag.

Refer to your Aston Martin Tracking User Guidebook.

Emotion Control Unit

The vehicle is supplied with three vehicle keys¹ (Emotion Control Units), a glass key, a spare key and an emergency key.



Keep the spare key in a safe place. Do not leave a vehicle key in the vehicle when unattended.

 If a vehicle key is lost, contact your Aston Martin Dealer.

Vehicle Key Security Functions

[1] LOCK: Press and release for one step vehicle locking and to arm the security system. The vehicle will deadlock after 25 seconds.

(Refer to 'Deadlocking', page 2.8)

[2] UNLOCK: Press and release for one step vehicle unlocking.

(Refer to 'Unlocking and Opening', page 2.4)

(Refer to 'Seat Memory Function', page 3.6)

[3] BOOT OPEN: Press once to release the boot lid catch (Refer to 'Boot Lid', page 2.7).

[4] APPROACH LIGHT: Press to set the front, rear side and interior lamps to ON (Refer to 'Approach Light', page 2.9).



¹ Manufactured by  STRATTEC. 8D33-70290-BG.

Emergency Key

In the unlikely event that either the vehicle key fails to operate or the vehicle battery is fully discharged use the emergency key to lock or unlock the vehicle.

Insert the emergency key in the door lock and turn fully towards the front of the vehicle, then release, to centrally lock the vehicle, disable the boot lid and fuel flap release switches. The security system will not arm.

To centrally unlock the vehicle, enable the boot lid and fuel flap release switches, turn fully towards the rear of the vehicle, then release. If the security system was armed, the alarm will start.

To stop the alarm insert the vehicle key (even if the vehicle key has lost all power) into the ignition control and move to position 'II' (ignition ON).

 *If the vehicle battery is fully discharged the emergency key will only lock or unlock a door.*

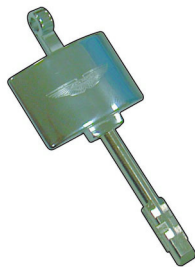

 *Even if the vehicle key has lost all power it will start the engine if required.*

 *Memory seats: The front seats and door rear view mirrors will not move to a preset position if the vehicle is unlocked using the emergency key.*

 *If the emergency key is lost, contact your Aston Martin Dealer.*

Unlocking and Opening

Stand within 5 m of the vehicle, point the vehicle key towards the vehicle and press the **UNLOCK** button. To show that the security system has been disarmed, the direction indicators will flash twice. All vehicle doors will unlock.

Push at point A and grab the emerging door release. Pull the door release to open the door.

If a door is opened while driving a warning sound will be heard until the door is closed.

 *If preferred you can unlock the drivers door only with the first press of the button and the rest of the vehicle with a second press (Refer to 'Personalisation', page 2.16).*

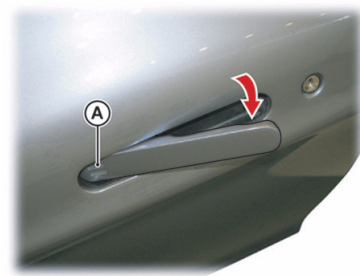

 For ease of use at night white LEDs are incorporated into the door handles. An LED will come ON in the door handles when the vehicle is unlocked. A door LED will go OFF once the door is opened. If a door is not opened the LEDs will go OFF after two minutes.

 If the vehicle has been opened using the spare key and the driver seat or door rear view mirrors have been adjusted, the seat and door rear view mirrors will move to the positions memorised by the key which is being used (Refer to 'Seat Memory Function', page 3.6).

 As the vehicle is unlocked, the interior lamps will come ON for five minutes. The lamps will go OFF 30 seconds after doors are closed or when the vehicle is started.

 If the door is left open the door puddle lamp will go OFF after eight minutes.

Unlocking From Inside the Vehicle

 **If reduced guard was not set to ON before locking the vehicle, deadlocking, interior movement and tilt sensors are enabled. Passengers will not be able to unlock a door from the inside.**

If reduced guard or automatic lock was set to ON before the vehicle was locked, one pull of a door handle will centrally unlock the doors, a second pull of the door handle will open that door.

(Refer to 'Automatic Lock', page 2.9).

(Refer to 'Reduced Guard', page 2.11).

Vehicle unlock from inside can be set to automatic unlock when the vehicle key is removed from the ignition control. With automatic unlock ON only one pull of a door handle will open that door (Refer to 'Personalisation', page 2.16).

When opening a door from inside the vehicle after reduced guard has been set to ON, the security system alarm will start. Press the **UNLOCK** button on the vehicle key to stop the alarm (there is approximately a ten second delay before the alarm is stopped).

Locking

 **If passengers are to stay in the vehicle after it has been locked, reduced guard must be set to ON before locking. This will let a passenger open a door from inside the vehicle.**

Make sure that all the doors, the boot lid and the bonnet are closed (the vehicle will not lock if a door is left open). Stand within 5 m of the vehicle, point the vehicle key towards the vehicle and press the **LOCK** button once to lock the doors, disable the boot lid and fuel flap release switches and arm the security system. The direction indicators will flash once as the security system is armed (Refer to 'Personalisation', page 2.16).

The driver's seat and both door rear view mirror positions are memorised and will be recalled the next time the vehicle is opened using the same vehicle key.

 The security system will arm and the doors will deadlock after 25 seconds.

 If the vehicle is locked with the boot lid open, the vehicle will lock and arm but deadlocking, tilt and interior movement sensors will not operate. Close the boot lid to arm the complete security system.

Automatic Re-locking

If the vehicle is locked and then unlocked but a door or the boot lid is not opened within two minutes, the vehicle will automatically lock and arm again.

Master Locks

All doors, fuel flap and boot lid release switches may be locked and unlocked by using the master lock switch (A). Press the switch to lock. Press again to unlock.

If the vehicle is locked using the master lock switch, one pull of a door handle will centrally unlock the doors, a second pull of the door handle will open that door.

The master lock switch will operate for seven minutes after the vehicle key has been removed from the ignition control, if the vehicle is not locked using the vehicle key.



The master lock switch will not operate if the vehicle has been locked from the outside.

Operation of the master lock switch will override automatic lock (Refer to 'Automatic Lock', page 2.9).

 When the vehicle is unlocked using the master lock switch the LED in each door handle will come ON (for 10 seconds or until the door is opened). This may aid access for passengers at night time.

 In the event of a vehicle accident the doors will automatically unlock.

Boot Lid

To Open the Boot Lid

Press the **BOOT OPEN** button on the vehicle key **once** to enable the release catch, then press the boot lid button (A) and lift the lid. Press the button **twice** (within three seconds) to enable the boot lid catch and release the lid. Lift the lid.

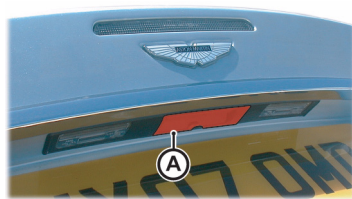

 *If the vehicle is locked and armed the security system will disarm and the direction indicators will flash twice when the boot is opened. The doors will stay locked (Refer to 'Personalisation', page 2.16).*

Opening from Inside the Vehicle

Pull back on the boot lid release switch (B). The boot lid catch will release¹. Lift the lid.

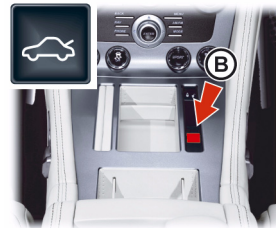

¹ The boot lid release switch becomes the roof raise and lower switch on the Volante.

To Close the Boot Lid

Grasp the leather pull (C) and pull the boot lid down, then push the boot lid down and make sure that its catch engages. Take care not to slam the boot lid shut. Press the **LOCK** button on the vehicle key to lock the lid. The direction indicators will flash once as the security system is armed (Refer to 'Personalisation', page 2.16).

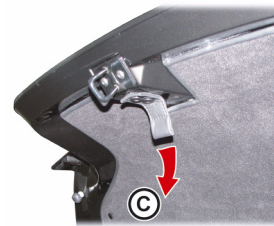

 *Always make sure that the boot lid is securely closed after use. The boot interior lamps will stay ON for seven minutes if the boot lid is left partially open and the vehicle key is removed from the ignition control.*

Vehicle Locked - Boot Lid Open

 To use a battery conditioner the boot lid has to be left open (boot lid down but not latched).

If the vehicle is locked while the boot lid is open, the vehicle will lock and arm (deadlocking, tilt and interior movement sensors¹ will not operate). If the boot lid is then closed (latched) deadlocking, tilt and interior movement sensors will operate and the whole vehicle will be locked and armed.

Boot Lid Emergency Open

The boot lid can be opened from inside the boot by pulling the luminous emergency release handle (D).

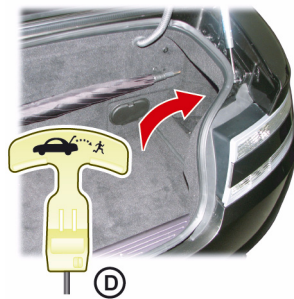

Deadlocking

 ***If passengers are to stay in the vehicle after locking, reduced guard must be ON before locking.***

The vehicle will automatically deadlock after 25 seconds after arming the security system. When the vehicle is deadlocked, the doors cannot be opened from the inside by pulling the interior door handle. To open the doors use the vehicle key.

¹. Option.

Automatic Lock

When automatic lock is set to ON the doors and the boot lid will automatically lock as vehicle speed reaches 7 km/h. This function prevents unwanted access to the vehicle when stopped at traffic lights, etc.

Press **MENU** (A). Navigate to <Car settings...> (Enter) <Lock settings...> (Enter) <Automatic settings...>. Select <Doors auto lock> or <Doors auto unlock on key out>. Press **ENTER** to toggle between ON and OFF.

Then press and hold **BACK** to accept and return to the main screen.



<**Doors auto lock**>: Set to ON: Doors and the boot lid automatically lock when the vehicle moves off. Set to OFF: Doors and the boot lid will not lock when the vehicle moves off.

<**Doors auto unlock on key out**>: Set to ON: The front doors and the boot lid automatically unlock when the vehicle key is removed from the ignition control. Set to OFF: One pull of a door handle will centrally unlock all doors, a second pull of the door handle will open that door.

 *Automatic lock is factory set to ON (Refer to 'Personalisation', page 2.16).*

 *In the event of a vehicle accident all doors will automatically unlock.*

Approach Light

When approaching the vehicle the side and interior lamps can be set to ON by pressing the **APPROACH LIGHT** button on the vehicle key. The time that the lamps stay ON is programmable (Refer to 'Personalisation', page 2.16).

Homesafe

When exiting the vehicle and the vehicle key has been removed from the ignition control, flash the main beam (pull the left side stalk up and release without latching) to set homesafe ON. The main beam and rear lamps will then stay ON for a determined amount of time and then go OFF. The time that the main beam and rear lamps stay ON is programmable (Refer to 'Personalisation', page 2.16).

Alarm

When the alarm has started a siren will be heard for a 25 seconds cycle (ten cycles maximum) and the direction indicators flash for five minutes after which the security system returns to the armed state. The doors and boot lid will stay locked throughout.

 *Markets where visible alarm signals and audible sirens are permitted.*

Stop the alarm at any time by pressing the **UNLOCK** button on the vehicle key or by inserting the vehicle key into the ignition control (position 'II'). There is approximately a ten second delay before the alarm is stopped).

 *Insert the key to position 'II' by using the flat of a finger, as shown.*

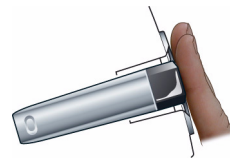

Interior Movement Sensor

Option

When the vehicle is locked and armed the interior movement sensor will sense movement inside the vehicle. If movement is detected it will start the alarm.

Tilt Sensor

Option

When the vehicle is locked and armed the tilt sensor will sense if the vehicle is tilted, for example, if the vehicle is being raised on a jack. If vehicle tilt is detected it will start the alarm.

Reduced Guard

⚠ Warning: *If a passenger is to stay in the vehicle after it has been locked, reduced guard must be set to ON before locking. In an emergency this will let a passenger open a door from inside the vehicle.*

When reduced guard is ON deadlocking, interior movement and tilt sensors are set to OFF. This will let a passenger open a door from the inside by pulling the interior door handle and a passenger or animals to be left in the vehicle with the security system armed.

If a door is opened from the inside, while reduced guard is ON, the security system alarm will start. Press the **UNLOCK** button on the vehicle key to stop the alarm at any time.

Reduced guard is set by using the car settings menu. Press **MENU** (A). Navigate to <Car settings...> Enter <Reduced guard...>. Select <Activate once> or <Ask on exit> and press **ENTER** to toggle between ON and OFF. Then press and hold **BACK** to accept and return to the main screen.



<Ask on exit>: Set to ON: Each time the vehicle key is moved from ignition position 'II' (ignition ON) to ignition position 'I' or '0' the message PRESS ENTER TO REDUCE GUARD. PRESS EXIT TO CANCEL will show in the message centre (right). The message will time out after one minute and reduced guard will not come ON. Set to OFF: No message will show and reduced guard will not come ON.

<Activate once>: Set to ON: Reduced guard will come ON for one time. Set to ON each time reduced guard is required. Set to OFF: Reduced guard will not come ON.

Reduced guard stays ON until the vehicle key is inserted in the ignition control and moved to position 'II' (ignition ON).

Passive Anti-Theft System

The Passive Anti-Theft System (PATS) is a fully automatic engine immobiliser.

 *If a vehicle key is lost, a duplicate key can be created and programmed from the spare key by your Aston Martin Dealer.*

Starting the Engine

When the security system is disarmed and the vehicle key is in the ignition control, the PATS controller sends a signal to the vehicle key. The vehicle key must respond with a valid code before engine start will be enabled. If a valid code is received, the ignition system will operate normally. If the vehicle key code is not received, or is invalid, engine start stays disabled.

PATS Status

The PATS system state is shown by the red symbol on the instrument cluster (A).



Ignition	Action (Valid code)
ON	Symbol comes ON for three seconds.
OFF	Symbol will flash.
OFF and the vehicle key removed from the ignition control	Symbol will flash for five minutes or one minute after the vehicle is locked using the vehicle key.

Fault Mode

If the status symbol continues flashing when the ignition is set to ON, the vehicle will stay immobilised.

Should this situation arise try removing and then inserting the vehicle key back to position 'II' in the ignition control. If this is unsuccessful try the spare key. If successful, get a replacement for the faulty vehicle key. If problems continue with the vehicle key, consult your Aston Martin Dealer.

Garage Door Opener

(Option: Available with auto dimming mirror only.)

The garage door opener (Homelink® Universal Transceiver) operating buttons and transceiver are located in the interior rear view mirror.

The transceiver can be programmed to transmit the radio frequencies of up to three different transmitters used to operate garage doors, entry gates, home lights, security systems, or other radio frequency operated devices.

 A full list of radio frequency operated devices can be either obtained via the HomeLink Hot-line or through the HomeLink compatibility list which is provided on the HomeLink website.

For information, or for assistance, contact your Aston Martin Dealer. Alternatively contact Homelink directly at www.homelink.com or call the HomeLink Hot-line:

Toll-free: 008000 0466 354 65

or

+49 6838 907-277 (In certain countries difficulties may be experienced trying to reach the toll-free number by some providers).

 **Warning: Do not use the transceiver with any garage door opening system that lacks the safety stop and reverse feature as required by safety standards. A garage door opening system which cannot detect an object, signalling the door to stop and reverse, does not meet current safety standards. Using a garage door opening system without these features increases risk of serious injury or death.**

 **Warning: When programming the transceiver to a garage door opening system, make sure that people, the vehicle and objects are out of the way to prevent potential harm or damage as the gate or garage door will operate during the programming.**

 Keep the original transmitter for future use or programming procedures if, for example, you purchase a new vehicle.

 This device may suffer from interference if operated in the vicinity of a mobile or fixed station transmitter. This interference is likely to affect the hand-held transmitter as well as the in-vehicle transceiver.

 The manufacturer is not responsible for any radio or TV interference caused by unauthorised modifications to this equipment. Such modifications could void the user's authority to operate the equipment.

Programming

 Step 1 erases all programming. It only requires completing if programming Homelink for the first time or when erasing all existing programming. It does not have to be followed to program the other HomeLink buttons.

 The HomeLink buttons can be reprogrammed individually but not individually erased. Step 1 must be completed to erase all programming.

1. Press and hold the two outer HomeLink buttons, releasing only when the HomeLink LED begins to flash after 20 seconds. All three buttons are now cleared. The HomeLink system is now in setting mode. As a security precaution make sure that all programming is erased in the HomeLink system before selling this vehicle.

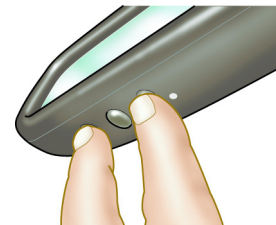

2. Hold the original remote control of the device to be programmed at a distance of 10-30 cm away from the HomeLink transmitter unit keeping the LED in view all the time. The distance between the remote control and the transmitter unit depends on the system being programmed. You may require several attempts at different distances. Maintain each setting position for at least 15 seconds before trying out another.

3. Using both hands, simultaneously push the remote control button and the desired button (1, 2 or 3).

4. The LED will flash, first slowly and then rapidly. When the LED flashes rapidly, release both buttons. The rapid flashing LED shows successful programming of the new frequency signal.



Operation

The vehicle should be within the operating range of the gate or garage door opener and the ignition should be ON.

The HomeLink system operates the garage door opener (or other device) in exactly the same way as the original remote control.

When you have programmed the HomeLink system, press the appropriate button 1, 2, or 3 on the control panel to operate the garage door opener.

The LED will come ON when the button on the control panel is pressed.

 *For convenience, the original remote control of the device may also be used at any time.*

In the case of a standard code, the HomeLink LED is constantly ON throughout the transmission process. For use with compatible systems, no further action is necessary.



If HomeLink now does not operate the garage door opener (or other device), this may be because the original remote control has a rolling code feature (Refer to 'Rolling Code Synchronisation', page 2.14).

Rolling Code Synchronisation

Check, by going through the following steps, whether or not the garage door opener (or other device) is equipped with a rolling code feature.

- Look in the garage door opener manual for clarification
- The remote control apparently programs HomeLink but HomeLink does not operate the garage door opener
- Press and hold down the programmed HomeLink button. With a rolling code system, the HomeLink LED flashes quickly for a short time and then stays ON constantly for two seconds. This pattern repeats itself for up to 20 seconds

If HomeLink was programmed with a rolling code system, then after the end of the programming period it must be synchronised with this system again before it will function correctly.

Follow the instructions below for Rolling Code Synchronisation (the procedure will take less time with a second person to help).

The vehicle must be within operating range of the garage door opener and the ignition set to ON. Make sure you comply with the safety instructions even when synchronising the rolling code.

1. Locate the Training button (programming button) on the garage door opener motor head unit. Exact location and colour of the button may vary by gate or garage door opener brand (refer to the operating instructions of the garage door opener 'Training additional remote controls').
2. Press the Training button (programming button) on the garage door opener motor head unit (which will usually set a 'training' LED to ON).

Following step 2, there are typically 30 seconds in which to initiate step 3.

3. Firmly press and release the programmed HomeLink button. Press and release the HomeLink button a second time to complete the training process. (Some garage door openers may require this procedure a third time to complete the training).

The garage door opener should now recognise the HomeLink signal and operate when the HomeLink button is pressed.

The next two buttons may now be programmed if this has not previously been done (Refer to 'Programming', page 2.13).

Reprogramming

If a HomeLink button has been programmed to operate a device, and you now wish to use this button to operate a different device, proceed as follows. This procedure will erase the existing programming of the respective HomeLink button.

1. Press the appropriate HomeLink button 1, 2, or 3 which requires reprogramming and keep holding it for about 20 seconds until the LED starts flashing slowly. Do not release until step 4 has been completed.
2. When the LED begins to flash slowly (after approximately 20 seconds), hold the remote control of the device you wish to use approximately 10-30 cm away from the HomeLink transmitter unit - keeping the LED in view.
The distance between the remote control and the HomeLink transmitter unit depends on the system being learned. You may require several attempts at different distances. Maintain each setting position for at least 15 seconds before trying out another.
3. Now press the remote control and keep it pressed.

4. The HomeLink LED will flash, first slowly and then rapidly. When the LED begins to flash rapidly, release both buttons.

Personalisation

A number of security functions can be personalised.

[1] **ON/OFF:** Infotainment centre ON and OFF

[2] **SCREEN:** Shows options, menus and information.

[3] **TUNING:** Turn (left or right) to navigate in the menus.

[4] **MENU:** Opens the main menu.

[5] **ENTER:** Select in the menu or open a selection.

[6] **JOYSTICK:** Navigate in the menus.

[7] **BACK:** Navigate back in the menu or cancel a selection.

Selection

With the vehicle key in ignition position 'I' or 'II', press **MENU** and navigate to the required setting and press **ENTER**. Use the **JOYSTICK** to make a selection and press **ENTER** to accept.



Menu

1) Car settings...

- 1) Reduced guard...
 - 1) Activate once
 - 2) Ask on exit

2) Mirror settings...

- 1) Auto mirror fold flat enabled
 - 1) Auto
 - 2) Passenger only
 - 3) Passenger and driver

3) Lock settings...

- 1) Automatic settings...
 - 1) Doors auto lock
 - 2) Doors auto unlock on key out
- 2) Doors unlock...
 - 1) All doors
 - 2) Driver door, then all

4) Light settings...

- 1) Lock confirm. light
- 2) Unlock confirm. light
- 3) Approach light duration...
- 4) Homesafe light duration...
 - 1) 30, 60 or 90 seconds

5) Information...

- 1) VIN number...

Before Driving

Checks Before Driving.....	3.2	Airbags.....	3.14
Seat Adjustment.....	3.2	Child Safety.....	3.16
Lightweight Seat.....	3.5	Passenger Airbag Deactivation.....	3.17
Sport Seat.....	3.3	Automatic Locking Retractors.....	3.18
Seat Memory Function.....	3.6	Child Seats.....	3.19
Steering Wheel.....	3.7	Cabin Storage.....	3.22
Interior Mirrors.....	3.8	Accessory Sockets.....	3.24
Door Mirrors.....	3.9	Electric Windows.....	3.24
Restraints System.....	3.10	Reading Lamps.....	3.25
Seat Belts.....	3.11	Coat Hooks.....	3.26

Checks Before Driving

Inspect your vehicle to make sure that everything is according to the information and specifications in this Owner's Guide.

Outside the vehicle:

- Visually check the road wheels, nuts and tyres
- Check that all windows, mirrors and lamps are clear and unobstructed
- Check that the boot lid, bonnet and fuel filler flap are securely closed
- Check the operation of all lamps

Once Inside the vehicle:

- Check that the doors are securely closed
- Check that the seat, mirrors and steering wheel adjustments are correct
- Check that all gauges and symbols are reading correctly
- Check that all passengers have fastened their seat belts

Seat Adjustment

Front seats only.

⚠ Warning: Do not attempt to adjust the drivers seat whilst driving.

! The vehicle key must only be inserted into the ignition control with the two indents first, as shown. To insert the larger end first the key may damage the ignition control.



The front seats can be adjusted while the vehicle key is in the ignition control. Gently insert the vehicle key up to position '1' (press down until the instrument cluster and infotainment centre lights come ON) and release.

They can also be adjusted:

- Up to six minutes after a door is unlocked and before the vehicle key is inserted into the ignition control
- Up to six minutes after the vehicle key is removed from the ignition control

If the seat operation times out:

- Place the vehicle key in the ignition control
- Close or open a door

The seat adjustment controls are located each side of the centre console (A).



Sport Seat

Seat Head Restraints

The driver and front passenger seats include non-adjustable head restraints (A), which limit the rearward travel of the head in a rear impact and may reduce whip lash injuries. When sitting in the seats make sure that the seat back is in an upright position and that the rear of the head is positioned in the centre of the head restraint area. The head restraints are most effective when the distance between the rear of the head and the head restraint is kept to a minimum.



Seat Adjustment

 *Memory Seats: When making seat adjustments, i.e. moving the seat base rearwards, raising or lowering the seat base, the seat back will motor forwards whenever it approaches trim panels located behind it. If the seat back is tilted backwards the seat base will move forwards if the seat back approaches trim panels.*

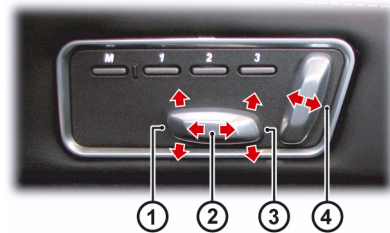

[1] : Raise or lower the **front** of the seat.

[2] : Move the seat **forwards** or **rearwards**.

[3] : Raise or lower the **rear** of the seat.

[4] : Raise or lower the **front** of the seat.

[5] : Press forwards or rearwards to increase or reduce the **lower lumbar support**.

[6] : Press forwards or rearwards to increase or reduce the **upper lumbar support**.

[7] : Press to the rear for the **lower** heat setting, press to the front for the **higher** heat setting. A LED shows which heat level is ON. Press to the centre position for OFF (LEDs OFF)¹.

 *The ignition must be ON before the heated seat and lumbar support can be operated.*



Seat Back Release

Press and hold in button A to release the seat back, once the seat has been moved forward release the button and manually move the seat back forwards.



 *In the unlikely event of power failure a manual release strap is provided in the seat back. Pull and hold the strap to release the seat back and then move the seat back forward.*

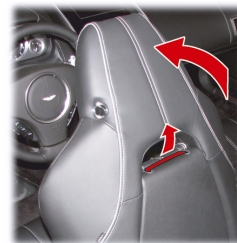

¹. Option.

Lightweight Seat

Option (2+0 seating only)

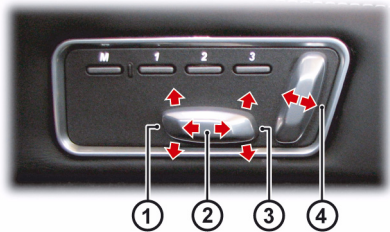

[1] : Raise or lower the **front** of the seat.

[2] : Move the seat **forwards** or **rearwards**.

[3] : Raise or lower the **rear** of the seat.

[4] : Raise or lower the **front** of the seat.

Lumbar Support

Two adjustable lumbar pads are located in the seat back.

To adjust the lumbar pad position.

1. Grab the top of the seat back panel (A) and pull away from the seat.
2. Locate the lumbar pads (B). Pull them from their velcro fixings and place in to a new position as required.

 *Avoid placing the lumbar pads on the strip of velcro which secures the seat back panel (C).*

3. Install the seat back trim (D).

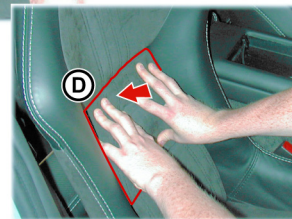
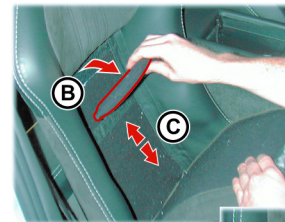
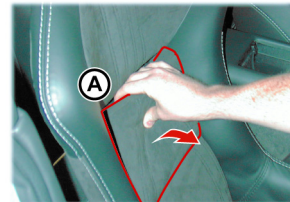

4. Repeat as required to find the correct lumbar support position.

Easy Access

⚠ Warning: Make sure that no person is sitting in the seat while Easy Access is being used. Forward movement will continue further than normal seat forward movement.

Easy access allows the seat to be moved forward, to provide greater access to the rear environment. Each seat has an easy access button located on each end of the dashboard (E). To move a seat press and hold the button (on the first press the seat will move forward). Movement will continue until the button is released.

If the button is released and pressed again within three seconds, movement will continue in the same direction. If the button is released and pressed again after four seconds the seat will start to move in the opposite direction. When moving rearwards the seat will return to its original position while the button stays pressed.

Locking the vehicle with a double press (vehicle key) will also return the seat to its driving position.

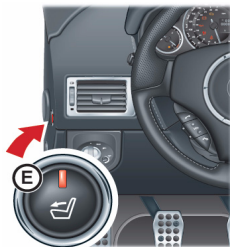

Seat Memory Function

⚠ Warning: Make sure that there is nothing in front of, behind, or under the seat during adjustment.

⚠ Warning: To avoid injury, make sure that children do not play with the switches

⚠ Warning: If the seat accidentally begins to move, press any seat control button to stop the seat.

The position of the driver and front passenger seats can be memorised and recalled.

Three different driving position profiles can be entered in the memory. The memory position of the driver's seat also includes both door rear view mirrors.

The memory function buttons are located in the seat adjustment controls which are located each side of the centre console (A).



Setting a Preset Position

⚠ Warning: Do not attempt to adjust the seat whilst driving.

Adjust the seat and the door rear view mirrors to the desired position¹.

- Mirror adjustment (Refer to 'Door Mirrors', page 3.9).

Push both the memory button (M) and the desired setting button (1, 2 or 3) simultaneously and release. A chime is heard and message will show in the message centre (right) to confirm². By repeating these steps and pressing an unused button, a second and third driving position can be stored in the memory.



¹. Mirror memory operates only when adjusting the driver's seat.
². Driver's seat only.

 When making adjustments to a set driving position, reset the new position in the same memory channel. The previous memory is erased when a new driving position is entered.

Recalling a Memorised Position

Once in the seat press and hold button 1, 2 or 3 (depending on which position required) until all movement is stopped. The seat and door mirrors (when adjusting the driver's seat) move to the programmed position. If the button is released all movement will stop, press and hold again to continue movement.

Memory Using the Vehicle Key

When the vehicle is locked using the vehicle key, the driver's seat and both door rear view mirrors will remember their positions. The next time the vehicle is opened using the same vehicle key, the seat and door rear view mirrors will move to the memorised position once the door handle is used.

 The seat and door rear view mirrors only move if they have been moved previously, i.e. the spare vehicle key has been used and the seats or mirrors have been moved.

Emergency Stop

If the seat accidentally begins to move, press any seat control button to stop the seat.

Steering Wheel

 **Warning: Do not adjust steering wheel whilst driving.**

 **Warning: Make sure that the steering column is fully locked in position. The reach and tilt release lever must be fully up, in line with the steering column.**

Reach and Tilt

The reach and tilt angle of the steering wheel are adjusted by using the release lever (A). Pull the release lever downwards and manoeuvre the steering wheel to the required position. Hold the steering wheel in the required position and lock it by pulling the release lever up.



Interior Mirrors

Rear View Mirror

Manual Dip

Adjust the rear view mirror on its ball mounting until a satisfactory rear view is obtained.

To avoid dazzle from headlamps of following vehicles use the dip lever (A) to raise or lower the mirror.



Automatic Dim

Option

Adjust the mirror on its ball mounting until a satisfactory rear view is obtained.

The rear view mirror will dim automatically if the glare from the headlamps of following vehicles becomes too bright. The mirror will return to normal view as unwanted glare reduces to an acceptable level. If the mirror is dimmed when reverse gear is selected the mirror will revert to normal view.



Vanity Mirror

A vanity mirror is located in each sun visor.



Door Mirrors

To adjust the door mirrors select the left or right mirror (B). Then move the joystick (A) up, down, left or right to adjust the selected mirror.

 *The vehicle key must at position 'I' or 'II' in the ignition control before the door mirrors can be adjusted.*

 *An amber LED shows the selected mirror.*

Heated Mirrors

When the heated rear window is ON the heaters in the door mirrors will operate for 6.5 minutes.

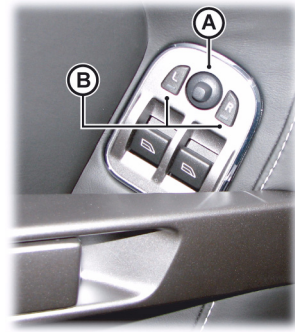

Power Fold Function

The power fold mirror function moves the door mirror assemblies until folded flat against the doors (folded).

Insert the vehicle key to position 'I' or 'II' in the ignition control. Move the mirrors to the folded position by pressing down and releasing both the left and right mirror select switches (B) together. The mirrors will motor to the folded position. Repeat to motor the mirrors back to the driving position.

Auto Fold function

When the vehicle is locked using the vehicle key the mirrors will automatically fold in flat against the doors. They return to the driving position once the vehicle is unlocked.

Press **MENU** (C) and navigate to <Car settings...> Enter <Mirror settings...> Enter <Auto mirror fold flat enabled>. Press **ENTER** to toggle between ON and OFF. Then press and hold **BACK** to accept and return to the main screen.

 *If the mirrors have been folded using the power fold function then the mirrors will stay folded until placed in the driving position using the power fold function again.*

 *Door mirror vibration can occur if the mirrors have been moved manually (folded or unfolded), either intentionally or accidentally. To reset the linkage operate the power fold function once to fold or unfold the mirrors.*



Reverse Dip Function

This function gives a better view to the rear of the vehicle while reversing.

When reverse gear is selected:

Automatic Mode: When reverse gear is selected the door mirrors automatically move to the first preset dip position. If the mirror requires further lowering, press down and release the joystick again. If the mirror is lowered too far, press the mirror joystick up and release.

Manual Mode: Press down and release the mirror joystick (A). This will lower the door mirrors to preset position 1 dip. If the mirror requires further lowering, press down and release the joystick again. If the mirror is lowered too far, press the mirror joystick up and release.

In manual or automatic mode the mirrors return to driving view when reverse gear is de-selected or when either mirror button (B) is pressed.

Reverse Dip Settings

Press **MENU** (C) and navigate to <Car settings...> Enter <Mirror settings...> Enter <Reverse mirror dip settings...>. Select <Auto (reverse gear selected)>, <Passenger only> or <Passenger and driver>.

Press **ENTER** to toggle between ON and OFF. Then press and hold **BACK** to accept and return to the main screen.

<Auto>: If set to ON: The door mirrors dip automatically when reverse gear is selected. If set to OFF: The door mirrors stay in manual mode.

<Passenger only>: Only the passenger door mirror dips.

<Passenger and driver>: Passenger and driver door mirrors dip.

Restraints System

The restraints system gives protection to the driver and all passengers in a variety of impact conditions. The system consists of:

- Driver and passenger safety belts with pre-tensioners and load limiting systems
- Driver and front passenger dual-stage airbags
- Driver and front passenger seat side airbags¹
- Front Passenger Airbag Deactivation (PAD) switch

All of these systems are controlled by a Restraints Control Module (RCM). In a collision the RCM will analyse information from various sensors, including crash and seat occupancy conditions. Based on this information the RCM will deploy the appropriate safety devices. During a crash, the RCM may or may not operate the safety belt pre-tensioners and none, one, or both stages of the dual-stage airbag supplemental restraints.

If the pre-tensioners or airbags do not operate in a collision it does not mean that something is wrong with the system. Rather, it means the system determined the accident conditions (crash severity, belt usage, etc.) were not appropriate to operate these safety devices.

¹. Sport Seat Only.

Front airbags are designed to operate only in frontal and near-frontal collisions, not rollovers, side-impacts, or rear-impacts unless the collision causes sufficient longitudinal deceleration.

Determining if the System is Operational

A warning symbol in the instrument cluster  shows the condition of the system. A difficulty with the system is shown by one or more of the following:

- The warning symbol will flash or stay ON
- The warning symbol does not come ON immediately after the ignition is set to ON

If either of these conditions occur, even intermittently, have the restraint system serviced at your Aston Martin Dealer immediately. Unless serviced, the system may not operate correctly in the event of a collision.

Seat Belts

Aston Martin strongly recommend the use of seat belts.

⚠ Warning: Seat belts should not be worn with straps twisted.

⚠ Warning: Each belt assembly must only be used by one passenger; it is dangerous to put a belt around a child being carried on the passengers lap. Do not put an adult seat belt around two children.

⚠ Warning: When installed, the seat belt webbing must not contact any sharp edges which could abrade or cut the webbing during normal use or in an accident. If necessary, the webbing must be protected.

⚠ Warning: Care should be taken to avoid contamination of the webbing with polishes, oils and chemicals, and particularly battery acid. Cleaning may safely be carried out using mild soap and water. The belt should be replaced if webbing becomes frayed, contaminated or damaged.

⚠ Warning: Wearing your seat belt is crucial to your safety. Not wearing a seat belt increases chance of serious injury or death in the event of an accident.

⚠ Warning: Be sure that you and your passengers always fasten their seat belts and use them correctly even though airbags are provided.

⚠ Warning: Reclining the seat back decreases protection provided by the seat belt in the event of a crash. Adjust the seat back to an upright position. Make sure that the seat back is locked in place. Otherwise it could move forward in the event of a sudden stop or crash and cause injury.

⚠ Warning: Seat belts are designed to bear upon the bony structure of the body, and should be worn low across the front of the pelvis, chest and shoulders; wearing the lap section of the belt across the abdominal area must be avoided.

⚠ Warning: Never place shoulder portion of belt under your arm or behind your back.

⚠ Warning: Always remove from your pockets rigid or breakable objects, i.e. spectacles or a mobile phone, which could be trapped under seat belts, possibly causing injury in the event of an accident.

⚠ Warning: Expectant mothers should seek medical advice on the most appropriate way to wear the seat belt.

⚠ Warning: Seat belts must be kept clean so that the retractor works correctly. Make sure that belt webbing is not twisted, looped, frayed or obstructed in any way. If in doubt about condition or operation of seat belt installation, have it checked by your Aston Martin Dealer.

⚠ Warning: No modifications or additions should be made by the user which will either prevent seat belt adjusting devices from operating, or prevent seat belt assembly from being adjusted to remove slack. Never install accessories on your seat belts.

⚠ Warning: Seat belts should be adjusted as firmly as possible, consistent with comfort, to provide the protection for which they have been designed. A slack belt will greatly reduce the protection afforded to the wearer.

⚠ Warning: It is essential to replace the entire seat belt assembly after it has been worn in a severe impact even if damage to the seat belt assembly is not obvious.

Pre-tensioner and Load Limiting

All seat belts are equipped with pre-tensioner and load limiting systems.

In most moderate frontal or near frontal accidents, the front airbag and all pre-tensioner systems will deploy simultaneously.

The pre-tensioners take up slack in the seat belts as the airbags are expanding. The load limiting system releases belt webbing in a controlled manner to reduce belt force on the passenger's chest.

 In some moderate frontal or near frontal accidents, only the pre-tensioner system will deploy.

Seat Belt Reminder

 A warning symbol in the instrument cluster will come ON and warning sound will be heard for six seconds (approximately) when the ignition is set to ON if the driver or front passenger₁ seat belt is not fastened₂.

-
1. If a passenger is sitting in the front passenger seat.
 2. Market area dependant

If the driver seat belt is not fastened after 60 seconds or if the vehicle reaches 25 km/h a warning sound will be heard for 30 seconds, after which the warning sound will go ON and OFF and the warning symbol will continue to show until the seat belt is fastened.

The warning messages are always available, press the **READ** button to view stored messages.

Seat Belt Fastening

 When parked on an incline, the seat belt may lock as it is withdrawn. This is not a fault. If the mechanism locks, release the belt tension and then pull the belt very gently to avoid operation of the inertia lock.

Each seat has three point, inertia reel seat belts installed. Items 1, 2 and 3 show the three points of the seat belt. Item 3 is also the location of the belt buckle.

The inertia belt reels will automatically tension the belts to provide security with comfort. In the event of a collision or during severe braking, the belt reels will lock.

Pull out the seat belt, drawing the tongue over the shoulder and across the chest.

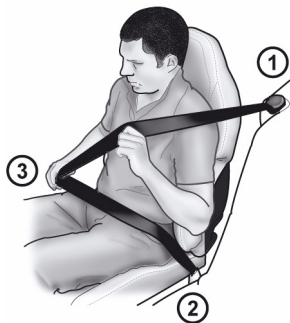

Push the tongue into the belt buckle latch until a positive click is heard.

Pull upwards on the diagonal belt to make sure that the latching is secure and to remove all slack from the belt.

Finally, double check that the lap belt is installed snugly, low down across the hips, and that there are no twists.

If it is necessary for a passenger to adjust their seat or seating position during a journey, the belt tension might be disturbed.

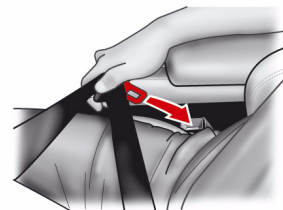

The passenger should therefore (as soon as it is safe to do so) gently pull down the shoulder run of the seat belt to create some slack and then immediately release it to re-tension the belt for the new seating position.

Seat Belt Unfastening

Depress the button on the buckle. While holding the seat belt tongue allow the belt to slowly retract to its stored position.

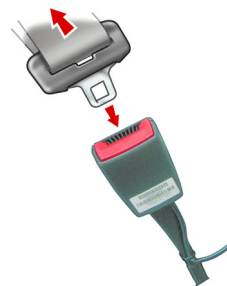

Child Seat Belt Fastening

⚠ Warning: An infant or child that is not correctly restrained can be seriously injured or killed in a crash. Seat belts are designed for adults and larger children; infants and smaller children must be restrained in an approved child safety seat.

Make sure that there is no slack in the webbing and that the restraint installs correctly across the child's rib cage and hips. These are the parts of the body most able to take the force of impact.

The lap strap should pass across the top of the child's thighs, bearing on the pelvis, not on the abdominal area.

Airbags

Supplemental Restraints System

The vehicle is equipped with driver and passenger airbags. The airbags and seat belt pre-tensioners are electrically controlled by the restraints system.

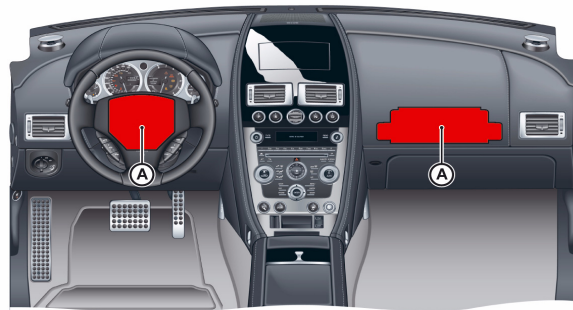

The front airbags (A) only deploy in a serious front collision. The side airbags, located in the front seats (B) only deploy according to which side has been impacted in a serious side collision¹.

The purpose of the airbags is to provide **additional** protection for the driver and passengers in the event of a serious impact (front or side impacts). The airbags are supplementary to the seat belts.

Important airbag safety labels are located on the sun visors and on the end of the instrument panel (passenger side). Make sure that the instructions on these labels are read and complied with before driving the vehicle.



¹. Sport Seat Only.

Airbag Deployment

⚠ Warning: The use of accessory seat covers may prevent the deployment of the side airbags and increase the risk of injury in an accident. Do not use accessory seat covers.

⚠ Warning: All passengers, including the driver, should always wear seat belts, whether or not an airbag is provided, to decrease the risk of injury or death in the event of a crash.

⚠ Warning: No objects whatsoever should be attached to the centre cover of the steering wheel or the front passenger fascia panel. Such objects could cause harm if the vehicle is in a collision severe enough to cause the airbags to deploy.

Airbags inflate rapidly and with considerable force; there is therefore a risk of death or serious injury such as fractures, facial and eye injuries or internal injuries, particularly to passengers who are not correctly restrained by seat belts or are not sitting correctly when the airbags deploy. The risk of injury from a deploying airbag is greatest close to the trim panel covering the airbag.

The whole sequence of events from sensing the impact to full inflation of the airbag takes place in a fraction of a second. The noise and gas associated with the deployment of the airbags is not injurious to health.

Do not change, modify or tamper with the steering wheel, passenger side fascia or any other part of the airbag system. Such actions could disable the system or cause inadvertent airbag deployment.

The system will not deploy in the event of minor frontal or side impacts, such as contacts when parking.

The airbag system is not designed to protect against rear impacts. All work on the airbag system must only be carried out by an Aston Martin Dealer.

[A] : Front airbag deployment

[B] : Front seat side airbag deployment

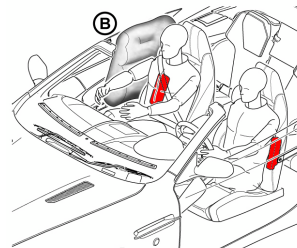
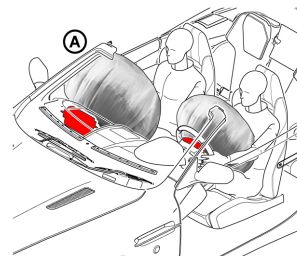

Child Safety

Aston Martin strongly recommends:

- Not to install any child seat on the front passenger seat of this vehicle.
- That all children are seated in the rear passenger seats¹.

A child, regardless of age, should always be restrained when travelling in a vehicle.

⚠ Warning: Accident statistics show that children are generally safer when correctly restrained in the rear seat than in the front seat. A suitable child restraint, correctly installed and used, provides the highest degree of protection for infants and small children in most accident situations ¹.

⚠ Warning: Do not allow children to travel in a vehicle without restraint. An appropriate child seat or harness should always be used.

⚠ Warning: Each seat belt assembly must be used by only one passenger. It is dangerous to put a seat belt around a child being carried on the passengers lap.

⚠ Warning: Make sure that an installed child seat does not rest against the door, that the child sits correctly in the seat and does not lean close to, or against, the door or window.

Your vehicle has the following devices for the installation of child restraints:

- Passenger Airbag Deactivation (PAD) switch²
- Passenger seats Automatic Locking Retractor (ALR) seat belts

Child Seats and Front Passenger Airbag

⚠ Warning: Do not use a child restraint on a seat protected by a front airbag which is set to ON.

⚠ Warning: With the exception of installing a child seat on the front passenger seat, do not set the PAD switch to OFF, as the front passenger will not receive the added protection of the airbag. Serious injuries or even death could occur.

⚠ Warning: Never place a child in a child seat or on a booster cushion on the front passenger seat if the airbag is set to ON.

If a child seat is to be used in the front passenger seat, the front passenger airbag **must** be set to OFF. Make sure that the child seat manufacturer's installation instructions are followed correctly.

In the event of a serious frontal or side collision the vehicle airbag system is designed to deploy, to provide additional protection for the front seat occupants.

 *The PAD switch does not set the front passenger side impact airbags or the seat belt pre-tensioners to OFF.*

Lightweight Seat

If a forward facing child seat is to be used in the passenger seat, follow the child seat manufacturer's instructions to secure the child seat and move the front passenger seat to its rearmost and lowest position.

Sport Seat

⚠ Warning: With the exception of installing a child seat on the front passenger seat, do not set the PAD switch to OFF, as the front passenger will not receive the added protection of the airbag. Serious injuries or even death could occur.

⚠ Warning: Never place a child in a child seat or on a booster cushion on the front passenger seat if the airbag is set to ON.

¹. 2+2 Seating Only

². Sport seat only.

If a child seat is to be used in the front passenger seat, the front passenger airbag **must** be set to OFF. Make sure that the child seat manufacturer's installation instructions are followed correctly.

 The PAD switch does not set the passenger seat side impact airbag or the seat belt pretensioners to OFF.

Warning Labels

 **Warning: Extreme Hazard: Do not use a rearward facing child restraint on a seat protected by an active airbag in front of it.**

The following warning labels¹ are located on the sun visors and on the end of the instrument panel (passenger side).





Passenger Airbag Deactivation

Sport Seat Only.

 **Warning: Before installing a child seat on the front passenger seat, the front passenger airbag must be set to OFF.**

 **Warning: Before driving always confirm that the PAD switch is in the appropriate position according to your requirements.**

 **Warning: With the exception of installing a child seat on the front passenger seat, do not set the PAD switch to OFF, as the front passenger will not receive the added protection of the airbag. Serious injuries or even death could occur.**

 The PAD switch does not set the front passenger seat side impact airbags or the seat belt pre-tensioners to OFF.

The Passenger Airbag Deactivation (PAD) switch lets the airbag protecting the front passenger be set to OFF. When the PAD is set to OFF a child seat may be installed on the front passenger seat. At ignition ON if the front passenger airbag is set to OFF 'PASS AIRBAG OFF' will show in the message centre (right).

The PAD switch is located on the passenger end of the instrument panel and is accessible when the front passenger door is open.

¹. Market area dependant.

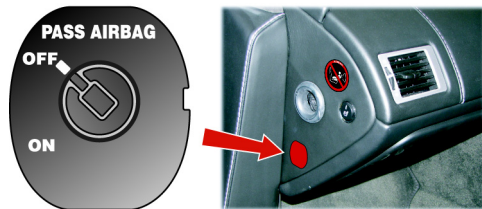

The PAD switch should be inspected by an Aston Martin Dealer if any of the following conditions occur:

- The PAD warning symbol does not come ON (for six seconds) when the ignition is set to ON and the passenger airbag is set to ON
- The PAD warning symbol does not stay ON when the ignition is set to ON and the passenger airbag set to OFF
- The PAD warning symbol stays ON when the ignition is set to ON and the passenger airbag is set to ON

Set the Airbag to ON or OFF

Insert the emergency vehicle key into the PAD switch and turn clockwise for the OFF position (airbag OFF) or counterclockwise for the ON position (airbag ON). Remove the key.

Airbag ON: When the ignition is set to ON make sure that the PASS AIRBAG OFF symbol comes ON for six seconds then goes OFF. Failure to follow the advice given above can endanger the life of the child.

Airbag OFF: Make sure that the PASS AIRBAG OFF symbol stays ON when the ignition is ON.



**PASS
AIRBAG OFF**

Automatic Locking Retractors

⚠ Warning: Always follow the child seat manufacturer's instructions. Not following the child-seat manufacturer's instructions when installing the child seat is dangerous.

Aston Martin does not recommend any specific child seat for this vehicle **which require the use of the vehicle seat belt for installation.**

The Automatic Locking Retractor (ALR) system is designed to securely hold child seats. The ALR system temporarily locks the seat belt that is securing a child seat.

ALR Operation

Gently pull out the seat belt until fully extended. The ALR system will only engage at the maximum extension point of the seat belt.

Thread the belt tongue through the child seat as instructed by the child seat manufacturer. Engage the tongue into the belt buckle.

Adjust the tongue position on the belt, if necessary, to make sure that the lower belt run is tight and then allow the upper run of the seat belt to fully retract until the child seat is securely held. The ALR system will be heard 'clicking' as the seat belt retracts.

When fully retracted, pull down on the upper run of the belt to check that the ALR lock has engaged.

Child Seats

 When parked on an incline, the seat belt may lock as it is withdrawn. This is not a fault. If the mechanism locks, release the seat belt tension and then pull the seat belt very gently to avoid operation of the inertia lock.

The ALR system will disengage when the seat belt is fully retracted. The seat belt may then be worn when required as a normal seat belt. Once the ALR is disengaged, the seat belt must be fully extended to re-engage the system on the next occasion that a child seat is installed.

⚠ Warning: Always follow the child seat manufacturer's instructions. Not following the child seat manufacturer's instructions when installing the child seat is dangerous.

⚠ Warning: Do not seat a child aged 12 or younger, or weighing 36 kg or less in the car without an appropriate child seat or booster cushion.

Aston Martin strongly recommends not to install any child seat on the front passenger seat of this vehicle.

Use of Child Seats

Look for the following when selecting a child seat:

- It should have a label certifying that it meets the applicable Safety Standards
- Carefully read the instructions supplied with the child seat. Make sure you understand them and can install and use the device correctly and safely in the vehicle

- Make sure that the child seat is appropriate for the child's weight and development. The label required by the standard or regulations, or instructions for infant seats, usually provide this information

An infant or child that is not correctly restrained can be seriously injured or killed in a crash. Seat belts are designed for adults and larger children; infants and smaller children must be restrained in an approved child seat.

Children could be endangered in a crash if their child seat is not correctly secured in the vehicle.

Never hold a baby or child on your lap while riding in the vehicle.

Consult with local manufacturers of forward facing restraint and booster cushions. These manufacturers can supply you with advice on the safety of their particular child restraints.

Check the seat manufacturers instructions for correct use and installation – use the correct size seat and correctly secure the seat in the vehicle in accordance with the manufacturers instructions. Be sure to read and follow the ‘Installation and Use Instructions’ provided with the child seat.

Child Seats - Seat Belt Installation

Sport Seat

2+2 Vehicle Only

Mass Group ¹	Seating Position	
	Front Passenger	Second Row Outboard
'0' Up to 10kg (0-9 months)	U ₂	X
'0+' Up to 13kg (0-18 months)	U ₂ .	X
'I' 9 to 18kg (9 months to 4 years)	U ₂ .	X
'II' 15 to 25kg (4 to 12 years)	U ₂ .	X
'III' (22 to 36 kg (4 to 12 years))	U ₂ .	X

1. As shown on the child safety seat packaging

2. Move the passenger seat to its rearmost and highest position.

Sport Seat

2+0 Vehicle Only

Mass Group ₁	Seating Position
	Front Passenger
'0' Up to 10kg (0-9 months)	U ₂
'0+' Up to 13kg (0-18 months)	U ₂ .
'I' 9 to 18kg (9 months to 4 years)	U ₂ .
'II' 15 to 25kg (4 to 12 years)	U ₂ .
'III' (22 to 36 kg (4 to 12 years))	U ₂ .

1. As shown on the child safety seat packaging

2. Move the passenger seat to its rearmost and highest position.

Lightweight Seat

2+0 Vehicle Only

Mass Group ₁	Seating Position
	Passenger
'0' Up to 10kg (0-9 months)	X
'0+' Up to 13kg (0-18 months)	X
'I' 9 to 18kg (9 months to 4 years)	X
'II' 15 to 25kg (4 to 12 years)	X
'III' (22 to 36 kg (4 to 12 years))	X

1. As shown on the child safety seat packaging

Cabin Storage

Table Key

L:: Suitable for particular child restraint systems. These restraints may be of the 'specific vehicle', 'restricted' or 'semi-universal' categories.

U:: Suitable for 'universal' category restraints approved for this mass group.

X:: Seat position not suitable for children in the mass group.

***::** Unsuitable for use with many child restraints due to limited space.

Supplied under EC Directive 77/541 and ECE Regulation 16.04.

Glove Box

Press the glove box button (A) to open. Push up to close.



Trinket Trays

Trinket trays, including mobile phone pocket, coin or credit card holder.



Cup Holders

⚠ Warning: Only use the cup holder when safe to do so.

⚠ Warning: Do not place hot drinks in the cup holder while the vehicle is in motion. There is a risk of scalding.

⚠ Warning: Use soft cups only. Hard cups or objects can cause personal injury in a collision.



Cubby Box

The armrest cubby box has an iPod, USB ports, an auxiliary socket and an accessory socket.

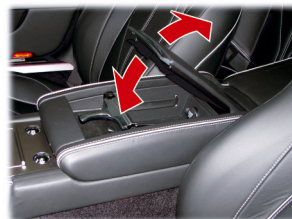

Door Pockets

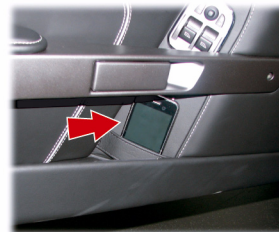

Front Seat Pockets

Sport Seat Only



Accessory Sockets

⚠ Warning: Damage to electrical circuits will result if more than 10 amps is drawn from the accessory socket. Only connect accessories which are designed for use in a motor vehicle.

⚠ Warning: Prolonged use of an accessory socket when vehicle engine is set to OFF may seriously discharge battery.

⚠ Foreign items can get into the socket and cause damage - always place the cover on the accessory socket when not in use.

Accessory sockets are mounted in the front armrest cubby box and the boot right side wall (A) and may be used to power any 12 volt vehicle accessory requiring a current of less than 10 amps.

 Vehicles installed with the non-smoking kit a third accessory socket is provided in the trinket box.

Read the manufacturer's instructions and make sure that you do not connect any device which would exceed current rating of the accessory socket.

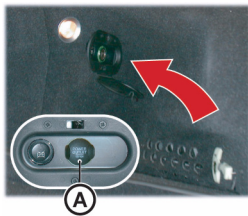

Electric Windows

⚠ Warning: Misuse of the window switches, especially by children, can result in injury due to entrapment in the window closure. Drivers must advise all passengers of the possible danger and make sure that all obstructions are clear before raising the window.

 Volante Only. Due to wind pressure when travelling at very high speeds the door windows may not close correctly.

 The windows can be operated up to one minute after the vehicle key is removed from the ignition control.

Each vehicle door has its own window switch and the drivers door window switch can operate both windows.

To raise and lower the windows the vehicle key must be at ignition position 'I' or 'II'.

Lightly press and hold a window switch (A) to lower the window in one movement. Lightly press and release the window switch to lower the window in stages. Firmly press and release to lower the window with one touch.

Lightly pull back and hold to raise the window in one movement. Lightly pull back and release, to raise the window in stages. Firmly pull back and release to raise the window in one movement.

If power to the electric windows has been interrupted for any reason, they will fail to operate correctly until reset (Refer to 'Door Window Reset', page 11.28).

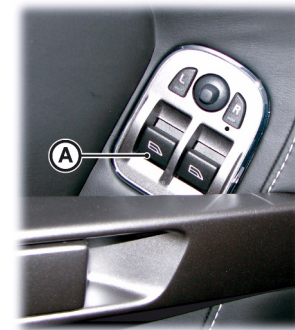

Rear Quarter Windows

Volante Only

When the roof is fully raised or fully lowered the rear quarter windows can be raised and lowered independently of the roof.

 *The door windows also raise and lower with the rear quarter windows. When the roof switch is released use the door window switches to raise or lower the door windows.*

To raise or lower the rear quarter windows push and hold the Roof switch (B):

- Pull forwards if the roof is fully raised

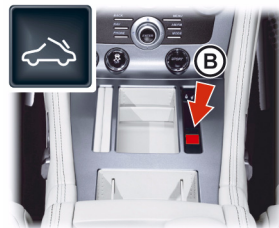

- Push rearwards if the roof is fully lowered
Release the switch and push again to change direction.

When lowering the window press the roof switch forwards and release for 'one touch' operation.

When raising the rear quarter windows, if the door windows were also lowered they will stop rising when half way up until the rear quarter windows are fully raised, then continue. If the door windows are to stay half raised, keep the roof switch pressed until the rear quarter windows are fully raised then release.

Door Sealing

 **Warning: Make sure that all passengers are clear when the window mechanism is operating.**

To minimise wind noise and to make sure that the window seal is watertight a door sealing system is used to provide a tight fit of the door glass to the seals around the top of the door opening.

When a door is opened, the window automatically lowers a small distance to clear the door seal. As the door is closed, the window automatically, after a pause, lifts against the body frame rubber seals.



Reading Lamps

Reading lamps are located in the front environment. To operate the lamps (ON or OFF) press the individual switches mounted on the front centre console (A).

Unless set to OFF or ON they will continue to operate up to six minutes after the ignition is set to OFF.



Coat Hooks

(Coupe Only)

Coat hooks are located behind the driver and passenger seats (A).

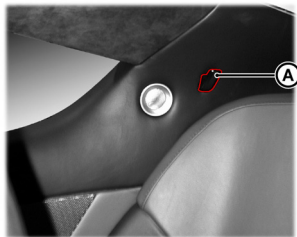

ASTON MARTIN



ASTON MARTIN

Controls

Controls Overview	4.2
Instrument Cluster.....	4.3
Information and Warning Symbols.....	4.4
Centre Stack Controls.....	4.8
Ignition Control	4.10
Stalk Controls	4.11
Master Lamp Switch	4.12
Trip Computer	4.13
Cruise Control.....	4.14
Ambient Temperature	4.16
Tyre Pressure Monitoring.....	4.16

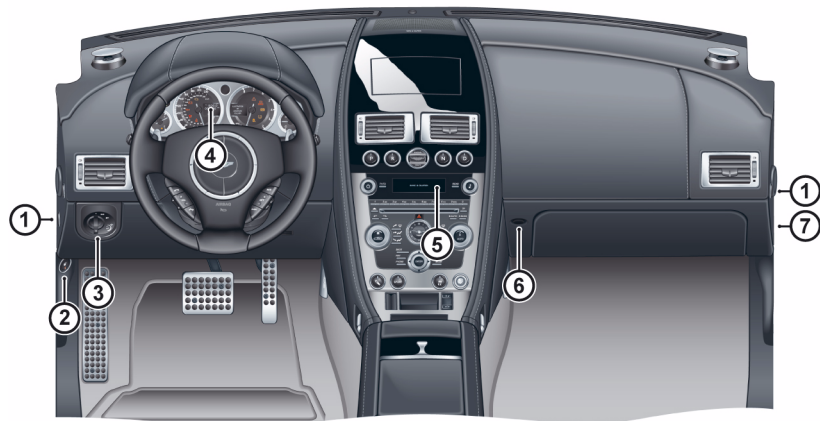

[1] EASY ACCESS: Easy access allows the seat to be moved forward, to provide greater access to the rear environment. Each seat has an easy access button located on each end of the dashboard¹.

¹. Lightweight seat only.

[2] FUEL FLAP RELEASE: Press to open the fuel flap. Close the fuel flap by pressing down on the flap until the lock engages.

Filler Flap Emergency Release: (Refer to 'Fuel Filler Flap Emergency Release', page 5.13)

[3] MASTER LAMP SWITCH: Three position master lamp switch, which controls the vehicle external lamps (OFF, side lamps and main lamps) (Refer to 'Master Lamp Switch', page 4.12).

[4] INSTRUMENT CLUSTER: (Refer to 'Instrument Cluster', page 4.3).

[5] CENTRE STACK: (Refer to 'Centre Stack Controls', page 4.8).

[6] GLOVE BOX RELEASE: Press to open the Glove box. Push the Glove box lid up to close.

[7] AIRBAG DEACTIVATION: The passenger airbag **must** be set to OFF if a child seat is to be installed on the front passenger seat² (Refer to 'Passenger Airbag Deactivation', page 3.17).



². Sport Seat Only.

Instrument Cluster



[1] **FUEL GAUGE:** Shows how much fuel is in the fuel tank. Refuel as soon as possible when the low fuel symbol comes ON.

[2] **SPEEDOMETER:** Shows vehicle road speed.

[3] **MESSAGE CENTRE (LEFT):** Shows the following:

- **Trip Meter (A):** Shows distances travelled since last reset of trip meters T1 and T2. Toggle between T1 and T2 by pressing **T1/T2** (F) for less than three seconds. Press **T1/T2** for more than three seconds to reset the trip meter on show.
- **Sport Mode Status (B):** Shows SPORT when sport mode is ON.
- **Gear Range (C):** Shows the transmission position and current gear selection. Possible transmission positions and gear selection are in bold.
- **Cruise Status (D):** Shows CRUISE when cruise control is ON (Refer to 'Cruise Control', page 4.14).
- **Odometer (E):** Shows the total distance covered by the vehicle.

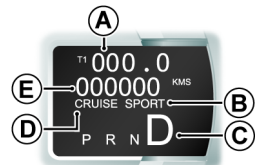

[4] GEAR POSITION INDICATOR:

Gear Position Indication Display (GPID): Shows the current gear when in paddle shift mode. Shows 'D' when in auto drive mode (Refer to 'Automatic Transmission', page 5.3). A red 'R' will show when the transmission is in reverse.



[5] MESSAGE CENTRE (RIGHT):

Shows the following:

- **Driver Information and Warnings**

Messages show if an unsatisfactory condition is detected. Message priority is shown by a red or amber triangle above the message display.

Red: Potential personal danger or danger of damage to the vehicle.

Amber: Advisory, shows possible degraded vehicle performance.

Warning messages will show when the ignition is ON and will cycle automatically.

View and acknowledge messages at any time by pressing the **READ** button (G).

- **Service Intervals**

TIME FOR REGULAR SERVICE will be shown when a regular vehicle service is due. This message will show at ignition ON (for two minutes) until the regular service has taken place.

- **Trip computer**

The message centre (right) defaults to the trip computer when there are no messages to show.

[6] TACHOMETER: Shows the engine speed in revolutions per minute x 1000.

[7] ENGINE COOLANT TEMPERATURE GAUGE: Shows the temperature of the engine coolant.



Information and Warning Symbols



[1] ● LOW FUEL WARNING: Comes ON when only approximately 9 ltr of fuel is available. At 9 ltr and 5 ltr an audible 'beep' will sound and the 'estimated distance' message will show (for 20 seconds) in the message centre (right). The arrow head shows which side of the vehicle the fuel flap is.



[2] LEFT TURN INDICATORS: Flashes with the indicator or hazard warning lamps (Ignition ON).



[3] HEADLAMPS: Shows that the main beam of the headlamps is in use.



[4] SIDE LAMPS: Shows that the side lamps, dip or main beams are ON.



[5] PATS: If this symbol flashes continuously at ignition ON the vehicle will stay immobilised. If the symbol is ON continuously at ignition ON the vehicle will start but PATS has gone into 'Fail Safe' mode (Refer to 'Passive Anti-Theft System', page 2.12).

Vehicles with Aston Martin Tracking Installed: If the PATS symbol continues to stay ON after the vehicle has started the driver recognition tag may not be in range of the tracking system.

⚠ Warning: Stop immediately if the check engine symbol flashes, do not drive the vehicle. Contact your Aston Martin Dealer.

[6]  CHECK ENGINE: Steady amber shows a fault in the engine management system. Continue driving only if there are no audible, visible or physical signs of degraded engine performance. Consult your Aston Martin Dealer as soon as possible.

Flashing amber shows a major fault in the engine management system. Stop immediately. Contact your Aston Martin Dealer.

[7]  IGNITION WARNING: Comes ON when the ignition is set to ON and goes OFF when the engine is started and battery charging commences. Comes ON if battery charging fails whilst driving.

[8]  OIL PRESSURE WARNING: Comes ON when the engine oil pressure falls below minimum. Do not continue driving if this symbol stays ON. Contact your Aston Martin Dealer immediately.

⚠ Warning: Do not drive the vehicle if the SRS warning symbol stays ON. Have the system checked by an Aston Martin Dealer.

[9]  SUPPLEMENTARY RESTRAINT SYSTEM: At vehicle key position 'I' and 'II' or on vehicle start up, this symbol comes ON for a few seconds as a readiness sign.

If it does not come ON, or if it does not go OFF after a few seconds, or if it comes ON whilst driving, the airbag self diagnostic system has detected a fault.

⚠ Warning: Do not drive the vehicle if the seat belt warning symbol stays ON. Have the system checked by an Aston Martin Dealer.

[10]  SEAT BELT WARNING: This warning symbol will come ON and a chime will sound for six seconds if the driver's seat belt is not fastened when the ignition is set to ON. The chime will continue to operate at different vehicle speeds until the seat belt is fastened¹.

¹. Market dependant.

[11]  WARNING TRIANGLE: Shows red or amber depending on the warning or information message priority.

⚠ Warning: If the brake warning symbol stays ON, after fully releasing the park brake do not drive the vehicle. Have the system checked by an Aston Martin Dealer.

[12]  BRAKE BRAKE WARNING: At ignition ON this symbol comes ON when the park brake is applied and goes OFF when the park brake is fully released. If the symbol stays ON, after fully releasing the park brake, it shows that either the brake fluid level is low or that the brake pads require regular maintenance.

⚠ Warning: If the ABS warning symbol stays ON, do not drive the vehicle. Have the system checked by an Aston Martin Dealer.

[13]  ABS WARNING: If this symbol stays ON or comes ON while driving there is a fault in the ABS control circuits. Continue driving only if there are no audible, visible or physical signs of degraded brake performance. Consult your Aston Martin Dealer as soon as possible if this symbol stays ON.



[14]  **TYRE PRESSURE:** If this symbol stays ON or comes ON while driving, a tyre(s) air pressure is below specification.

[15]  **DYNAMIC STABILITY CONTROL:** When Dynamic Stability Control (DSC) is ON this symbol will flash when the DSC system is operating. If, while DSC is ON, the DSC symbol stays ON or it comes ON whilst driving, the DSC system has detected a fault. A DSC fault message will show in the message centre (right). Consult your Aston Martin Dealer as soon as possible.

[16]  **REAR FOG LAMP:** Shows if the rear fog lamps are ON.

[17]  **RIGHT TURN INDICATORS:** Flashes with the indicator or hazard warning lamps (Ignition ON).

[18]  **HIGH COOLANT TEMPERATURE:** Shows when the engine coolant temperature exceeds 120°C.

Engine Oil Level Sensing

 **The electronic engine oil level sensing system does not replace the need for the owner to regularly check their engine oil using the dipstick. Check the engine oil level every fourth fuel tank fill or weekly - which ever is the soonest.**

This vehicle has an electronic engine oil level sensing (OLS) system which records the engine oil level each time the fuel tank is filled with 25 litres or more of fuel.

 **Running the engine with engine oil below the minimum mark on the dipstick can cause serious engine damage.**

 *The system may not record an oil level if the engine oil temperature is low or if the time to refuel is not sufficient for a consistent oil level to be recorded.*

For the correct engine oil refer to Fluids and Capacities (Refer to 'Fluids and Capacities', page 12.9).

If the engine oil level is low the message OIL LEVEL LOW ADD 1L will show in the message centre (right) along with an amber warning triangle and a chime sound. The engine oil level is low and should be topped up with one litre of engine oil as soon as possible.

The engine oil level should then be checked and topped up as soon as possible (Refer to 'Fluid Levels', page 11.8).

Press the **READ** button to acknowledge the message. The message will clear when the ignition is set to OFF and then ON.

Low Outside Temperature

⚠ Warning: Even if the ICE WARNING message does not show, there is no guarantee that at low temperatures the road is free from ice.

At temperatures below 4°C the message ICE WARNING is shown in the message centre (right), this shows to the driver that frost or ice is likely to form on road surfaces.

The amber warning triangle  will also come ON.

The message and warning triangle will continue to show until the outside temperature rises to a safer level.

Warning Symbols

As the ignition is set to ON, the electronic control units complete a self check. During these checks the following symbols will come ON for five seconds and SYSTEM CHECK will show on the message centre (right).



Under normal circumstances most warning symbols will go OFF at the end of the individual system check if system checks are satisfactory.

Centre Stack Controls

[1] SATELLITE NAVIGATION

SCREEN₁: Opens when the Satellite Navigation system is set to ON (Refer to 'Satellite Navigation', page 10.1).

[2] IGNITION CONTROL: Insert the vehicle key for ignition positions '0', 'I', 'II' and engine start (Refer to 'Ignition Control', page 4.10).

[3] TRANSMISSION CONTROLS:

Automatic: park, reverse, neutral and drive controls (Refer to 'Automatic Transmission', page 5.3).

[4] AIRBAG STATUS: Shows the passenger airbag status (Refer to 'Passenger Airbag Deactivation', page 3.17).

[5] DISPLAY: Shows options, menus and information.



[6] HAZARD WARNING LAMP: Press to set the hazard warning lamps to ON or OFF.

[7] CLOCK:

- Vehicles with Aston Martin satellite navigation:
To set the time press **MENU**. Go to <Car settings...> Enter <Clock>.
- Vehicles with Garmin satellite navigation:
To set the time press **NAV**. Use the satellite navigation screen and go to <Settings> Enter <Time>.

[8] READ: Press to view and acknowledge messages.

[9] AUDIO CONTROLS: (Refer to 'Audio', page 8.1)

[10] CLIMATE CONTROLS: (Refer to 'Climate Controls', page 6.2).

[11] MODE AND MENU NAVIGATION: Select functions and move back in the menus. Use the joystick to navigate for menus, music tracks, radio stations. Press to accept.

[12] READING LAMPS: Driver and passenger reading lamps.

[13] T1/T2: Select between two trip meters (Refer to 'Instrument Cluster', page 4.3).

[14] ADAPTIVE DAMPING: The Adaptive Damping System (ADS) defaults to normal mode at each ignition ON. Press and release for ADS sport mode (button LED ON) (Refer to 'Adaptive Damping', page 5.11).

[15] DYNAMIC STABILITY CONTROL: The Dynamic Stability Control (DSC) system defaults to ON at each ignition ON. Press and hold for approximately four seconds for sport mode. Press and hold again for approximately four seconds to set DSC to OFF. Press and release to set DSC ON again (Refer to 'Dynamic Stability Control', page 5.9).

[16] PARKING ASSIST: Defaults to OFF at each ignition ON. Park assist comes ON when reverse gear is selected. Press and release to set parking assist to OFF (Refer to 'Front and Rear Parking Assist', page 5.14) or (Refer to 'Rear Only Parking Assist', page 5.15).

[17] REAR FOG LAMPS: Used with the dipped beam when fog or mist is causing restricted visibility. They **must** be set to OFF when visibility clears to reduce glare to the drivers of following vehicles.

¹. Not available in all markets.

[18] MASTER VEHICLE LOCK: Press to lock all doors and disable the boot lock switch. Press again to unlock (Refer to 'Master Locks', page 2.6).

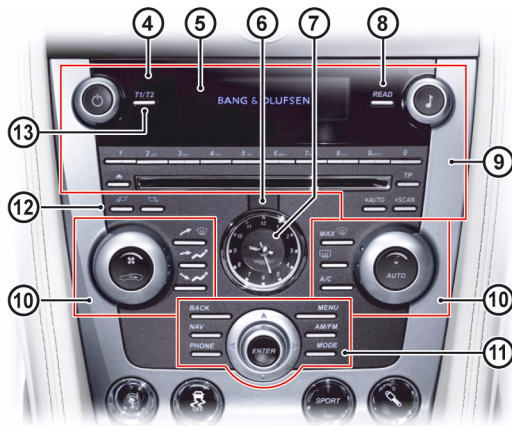

[19] BOOT OPEN: Pull back up to open the boot lid¹.

[20] SPORT MODE: Press the sport button once to enter transmission sport mode and press again to exit (Refer to 'Sport Mode', page 5.6).

[21] LAMY PEN HOLDER: Push the pen in and release to access the pen.

¹. On Volante this is the roof raise and lower switch.

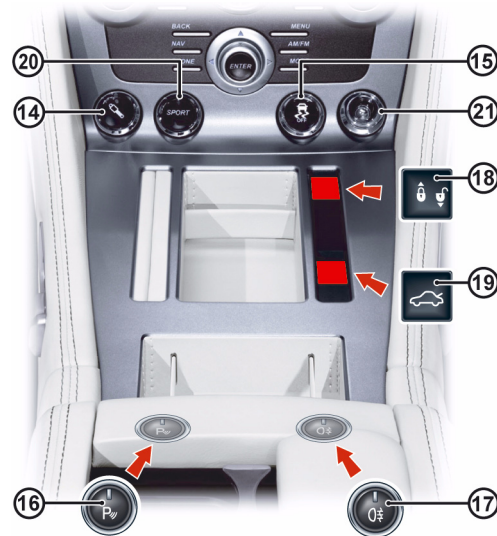

Ignition Control

To access vehicle functions and to start the engine the vehicle key must be inserted in to the ignition control.



⚠ Warning: Only use the vehicle key in the ignition control. Do not place any objects, including fingers, into the ignition control other than the vehicle key. Objects other than the vehicle key may cause the ignition control to fail.

⚠ The vehicle key must only be inserted into the ignition control with the two indents first, as shown. Attempting to insert the larger end first the key may damage the ignition control.

Position '0' (Ignition OFF)

Auxiliaries OFF (audio, satellite navigation, hands-free phone not available), steering lock ON. Seats can be adjusted.

Gently insert the vehicle key, indents first, into the ignition control. Press in until the key clicks into place (approximately 20 mm (A)) then release. The key is docked at this point.

Remove by pulling the vehicle key from the ignition control.

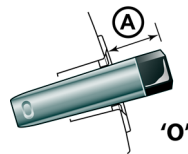

Position '1' (Ignition OFF and Accessories ON)

Auxiliaries ON (audio, satellite navigation, hands-free phone available), steering lock ON.

- If already in position '0' gently press the key until the infotainment centre and the instrument cluster lamps come ON (a further 10 mm (B)) and release for position '1'.
- Or insert the key into the ignition control and move straight to position '1'. Press in until the infotainment centre and the instrument cluster lamps come ON.

Remove by pulling the vehicle key from the ignition control.

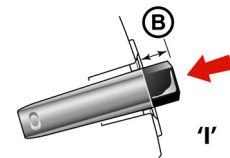

Position 'II' (Ignition ON)

Ignition and all other electrical systems ON, steering lock OFF.

! Do not press the brake pedal unless intending to start the engine.

 Insert the key to position 'II' by using the flat of a finger, as shown.

- If the key is already in position '0' or 'I' gently press the key until it is flush with the ignition control bezel and release.
- Or insert the key into the ignition control and move straight to position 'II'. Gently press the key until it is flush with the ignition control bezel and release.

The Instrument cluster lamps will come ON, the vehicle systems will wake up and the steering lock will release.

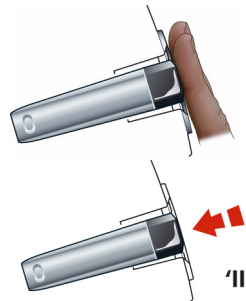

To start the engine from this position fully press the brake pedal down and press the key fully in (Refer to 'Starting the Engine', page 5.2).

To remove the vehicle key from position 'II' press the key fully in **twice** (do not press the brake pedal) and release. The key will gently return to position 'I'. Pull the key from the ignition control. Once in position 'I' after 10 seconds the steering lock will engage.

 If the vehicle key is pressed **fully** into the ignition control and released for position 'II', the key must be returned to position 'I' to start the engine.

Preventing Unnecessary Battery Drain

If the vehicle key is left in the ignition control (position '0'), some vehicle circuits will stay ON and unnecessary current will be drawn from the battery.

Always remove the vehicle key from the ignition control whenever the ignition is set to OFF.

Stalk Controls

Left Side Stalk

Turn Signals: Press up for a right turn, press down for a left turn. Returns to the centre position on completion of a manoeuvre. Hold against spring pressure to show a lane change.

Main and Dipped Beam: Pull forwards and latch for main beam. Pull forwards again and latch to return to dipped beam. Pull forwards and release without latching, at any time while the vehicle key is in the ignition control, to flash main beam ON and OFF.

Pull forwards and release without latching, when the vehicle key is removed, to start Homesafe (Refer to 'Homesafe', page 2.10).

Trip Computer: Repeated pressing of the trip function button (A) moves through the trip computer displays. (Refer to 'Trip Computer', page 4.13).

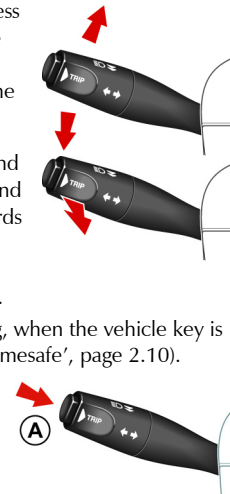

Right Side Stalk

Windscreen Wiper Control

[1] : OFF.

[2] : Intermittent Wipe.

[3] : Normal Speed Wipe.

[4] : Fast Wipe.

Demand Wipe

Pull the stalk forwards.

 The windscreen wipers will return to their park position if the ignition is set to OFF or the bonnet is unlatched, regardless of the right stalk position.

Speed Sensitive Wipe: If the wipers are at fast wipe, when the vehicle slows down (below 11 km/h) the wipers will go to normal wipe speed.

If the wipers are at normal speed when the vehicle slows down (below 11 km/h) the wipers will go to intermittent wipe (position 2).

As soon as the vehicle speeds up (above 15 km/h) the wipers will return to their original setting.



Windscreen Wiper Delay Control:

Intermittent wipe time delay increases or decreases in six steps (B). Sixth position gives the shortest delay between wipes.

Windscreen Washer Control: Press the button (C) for more than one second to operate the windscreen washers.

Operation continues until the button is released. When released the washers stop immediately but the wipers continue for a few strokes, ending with a pause and then a final wipe.

If used during normal wiper operation, the wipers operate continually irrespective of the washer operation.

Headlamp Washers: Headlamp washers will operate automatically, once per journey (each ignition ON), if the windscreen washers are operated and the headlamps are ON.

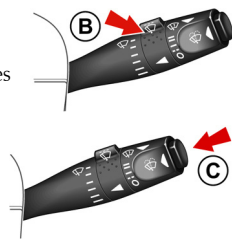

Master Lamp Switch

[1] : All external lamps OFF.

[2] : Side, side marker, rear and registration plate lamps ON.

[3] : With the vehicle key at position 'II' in the ignition control, Headlamps ON, in addition to the side, side marker, rear and registration plate lamps.

Lamps ON Warning

If the vehicle side lamps are ON, and the drivers door is opened after the vehicle key has been removed from the ignition control, an audible warning will sound for a period of five minutes. To stop the audible warning set the lamps to OFF. The audible warning will also stop when the driver's door is shut - the lamps will stay ON.

Day Time Running Lamps

(Denmark, Norway and Sweden only)

The dipped beams and side lamps are permanently ON.



Instrument Brightness

During the daylight hours the level of instrument brightness defaults to maximum brightness.

 If the twilight sensor is covered the level of brightness will stay low as if in night time mode.

The level of brightness can be reduced by using the rotary control (B). If the brightness level has been adjusted, the twilight and night time brightness level will return to the previous setting on the rotary control, each time the sensor picks up the twilight hours.

Push the rotary control in and release to enable the control. Push in and release to lock the control.



Trip Computer

Press the button (A) for less than three seconds cycles through the trip computer functions one at a time. Trip computer information is viewed in the message centre (right).

 If an information message shows, after reading and acting on the information provided press the **READ** button (B) to return to the trip display.

Range: Estimated travel distance with fuel available (no reset). The minimum distance shown will read 20 KM. Below this distance will show '- - -'.



Average Fuel: Average fuel consumption since last reset. Press A for more than three seconds but less than five seconds to reset. Press A for five seconds or more will reset both the average fuel consumption and average speed. INFOCENTER IS RESET will be shown in the message centre (right). Press the **READ** button to acknowledge the message.

Instantaneous Fuel: Shows the fuel consumption over the last three seconds of travel (no reset).

Average Speed: Shows the average speed since last reset. Press A for more than three seconds but less than five seconds to reset. Press A for five seconds or more will reset both the average speed and average fuel consumption. INFOCENTER IS RESET will be shown in the message centre (right). Press the **READ** button to acknowledge the message.



Present Speed: Shows the current vehicle speed.

 Driver aid only.

 Trip computer default screen.

Tyre Pressure Monitor: Shows the current tyre pressure for all tyres (Refer to 'Tyre Pressure Monitoring', page 4.16).

Blank Screen: Blank screen will show.

Display Units

The display can be set to show metric or imperial units.



With the ignition ON press the **READ** button (C) and the Trip Computer button (D) together for two seconds to change the trip computer display units.



Cruise Control

Cruise control can be used to maintain a selected vehicle speed, above 30 km/h, without having to use the accelerator.

[1] RES: Resume the set speed retained in memory.

[2] SET: Set the speed, accelerate or decelerate.

[3] ON/OFF: Sets cruise control to ON or OFF.

[4] CAN: Cancels cruise control but keeps the set speed in memory.

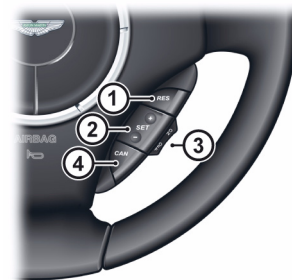

Operation

 **Warning:** Only use cruise control when conditions are favourable, for example, straight, dry, open roads with light traffic.

Use the **ON/OFF** switch (3) to set cruise control ON and OFF. When cruise control is ON 'CRUISE' will show in the message centre (left). When travelling at the desired speed, which must be above 30 km/h, press **SET** (+ or -) (2). Cruise control will engage and maintain that speed without the need to use the accelerator pedal.

 Under certain conditions cruise control will automatically set to OFF (Refer to 'Cruise Control Automatic OFF', page 4.15).

 Cruise control will automatically disengage when the brake pedal is pressed or when the vehicle speed falls below 30 km/h.

Changing the Set Speed

There are three ways to change the set speed:

- Accelerate or decelerate to the desired speed then press **SET** (+ or -).
- Accelerate or decelerate to the desired speed by pressing and holding **SET** (+ or -) until the desired speed is obtained, then release.
- Accelerate or decelerate to the desired speed in steps of 2 km/h by briefly pressing and releasing **SET** (+ or -) until the desired speed is obtained.

Resuming the Set Speed

 **RES should only be used if the driver is aware of the set speed and intends to return to it.**

 **It is not recommended to resume set speed when a low gear is selected as excessive engine speeds will occur.**

 Cruise control will not resume at speeds below 30 km/h. **RES** will not operate if the ignition has been set to OFF.

If the vehicle is accelerated above the set speed, then the set speed will be resumed when the accelerator pedal is released.

If **CAN** (4) is pressed, or the brake or clutch pedal is pressed, cruise control will disengage but the set speed memory will be kept. Press **RES** (1) and the vehicle will return to the set speed.

Cruise Control Automatic OFF

Cruise control will automatically set to OFF and clear the memory when:

- The ignition is set to OFF
- A fault occurs. The cruise control system will set to OFF and cannot be used until the fault is cleared
- The park brake is applied
- Maximum vehicle speed is reached

Cruise control will automatically set to OFF but the set speed will stay in the memory when:

- The **CAN** button is pressed
- The brake pedal is pressed
- Vehicle speed falls below 30 km/h

- Neutral, Park or Reverse gear positions are selected
- The difference between the actual and set speed is too great
- When the set speed is above 144 km/h; cruise control will disengage automatically after approximately 20 minutes
- The accelerator pedal is used to accelerate beyond the set speed for too long a period

Ambient Temperature

The ambient temperature (outside temperature) is shown in the top right corner of the Infotainment centre display.

 *If the vehicle has been travelling and then is stopped in a shaded or enclosed area the ambient temperature may rise, this is due to the heat from the engine bay. The ambient temperature display will show the true ambient temperature once the vehicle is moving again or the engine bay cools down.*

 *If required the display units can be changed from °C to °F or °F to °C (Refer to 'Climate Controls', page 6.2).*

Tyre Pressure Monitoring

 **Warning: Driving on a significantly under-inflated tyre causes the tyre to overheat and can lead to tyre failure. Under-inflation also reduces fuel efficiency and tyre tread life, and may affect the vehicle's handling and stopping ability.**

Each tyre should be checked monthly when cold, in the ambient air temperature that the vehicle is normally driven. Setting tyre pressures in a warm garage and then driving in a very low ambient may result in a low tyre pressure warning. Set the correct pressure recommended by the vehicle manufacturer on the vehicle placard or tyre inflation pressure label (if your vehicle has tyres of a different size than the size shown on the vehicle placard or tyre inflation pressure label, you should make sure of the correct tyre pressure for those tyres).

As an added safety feature, your vehicle has been equipped with a Tyre Pressure Monitoring System (TPMS) that sets a tyre pressure telltale (warning) symbol to ON (A) when one or more of the tyres is significantly under or over inflated. At the same time an image of vehicle in the message centre (right) will show which tyre(s) have low or high air pressure and the current tyre pressure. When the tyre pressure telltale comes ON, stop and check your tyres as soon as possible, and inflate or deflate them to the correct pressure.

 The TPMS is not a substitute for correct tyre maintenance, and it is the driver's responsibility to maintain correct tyre pressures, even if under-inflation has not reached the level to set the TPMS tyre pressure telltale symbol to ON.

Malfunction Telltale

Your vehicle has also been equipped with a TPMS malfunction telltale to show when the system is not operating correctly. The TPMS malfunction telltale is combined with the tyre pressure telltale.

When the system detects a malfunction, the telltale will flash for approximately one minute and then stay ON. This sequence will continue upon subsequent vehicle start-ups as long as the malfunction exists.



When the malfunction telltale is ON, the system may not be able to detect or send tyre pressure as intended. TPMS malfunctions can occur for a variety of reasons, including the installation of replacement or alternate tyres or wheels on the vehicle that prevent the TPMS from operating correctly.

Always check the TPMS malfunction telltale after replacing one or more tyres or wheels on your vehicle to make sure that the replacement or alternate tyres and wheels allow the TPMS to continue to function correctly.

Operation

⚠ When a tyre pressure warning is detected reduce the vehicle speed to an appropriate safe level and stop at the first safe and convenient place to inspect the tyre(s).

At each ignition ON there is a short delay before tyre pressures are received, from the wheel and tyre transmitters, and shown in the message centre (right).

If the tyre telltale symbol comes ON while driving, reduce speed to 48 km/h and stop in safe place as soon as possible. Check the status of the tyre(s) in the message centre (right):

Warning One

Telltale Symbol

Constant

Message centre (right)

CHECK TYRES (for ten seconds) followed by an image which shows which tyre(s) is affected and the current tyre pressures.

Fault

Tyre pressure below or above specification

Action

Check the tyre pressure of the affected tyre(s). Set the tyre pressure to the manufacturer's recommended pressure, as shown on the tyre label located on the edge of driver's door or the B-Pillar.



Warning Two**Telltale Symbol**

Flashing for 75 seconds then constant

Message centre (right)

TYRE SYSTEM FAULT (for ten seconds) followed by an image which shows which tyre(s) is affected and the current tyre pressures or which transmitter is at fault.

**Fault**

System failure or tyre transmitter fault

Possible Cause

- The TPMS sensors have become defective
- Wheels and tyres have been installed which do not have TPMS sensors
- An unapproved accessory is interfering with the TPMS
- A general fault has been detected in the TPMS

Action

Continue at a reduced speed of 48 km/h maximum. Have the control unit and the tyre transmitters checked at the earliest opportunity.

Consult your Aston Martin Dealer

Display Units

The display can be set to show metric or imperial units.

With the ignition ON press the **READ** button (C) and the Trip Computer button (D) together for three seconds to change the trip computer display units.



ASTON MARTIN

Driving

Driving Safety.....	5.2	Anti-Lock Braking System	5.8
Starting the Engine	5.2	Dynamic Stability Control.....	5.9
Automatic Transmission.....	5.3	Adaptive Damping	5.11
PRND Buttons.....	5.4	Park Brake.....	5.12
Touchtronic Controls.....	5.5	Fuel Filling.....	5.12
Sport Mode.....	5.6	Catalytic Converters	5.14
Fault Conditions.....	5.6	Front and Rear Parking Assist.....	5.14
Footbrake.....	5.7	Rear Only Parking Assist	5.15
		Driving Techniques	5.16

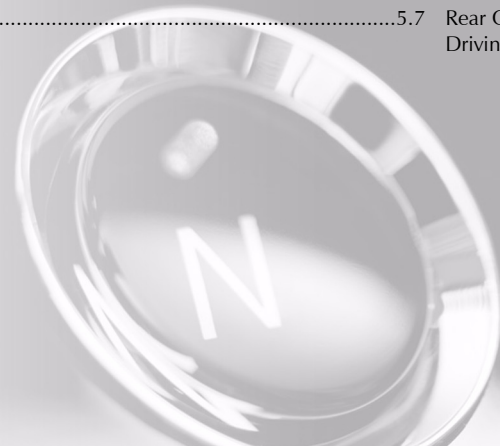

Driving Safety

- Always wear your seat belt
- Never drive under the influence of alcohol or drugs
- Always obey all speed and traffic laws and regulations. Never drive faster than the posted speed limit or than conditions allow
- Be particularly careful driving on slippery or wet surfaces
- This vehicle is a high performance vehicle and has handling characteristics you may not be accustomed to. Familiarise yourself with the vehicle and always drive prudently, being aware of your own limitations and the limitations of the vehicle. As with other vehicles of this type, failure to operate the vehicle correctly can result in accident and injury
- Follow the maintenance schedule approved in this guide
- Never allow the vehicle to be driven by inexperienced drivers

Starting the Engine

⚠ Warning: Only use the vehicle key in the ignition control. Do not place any objects, including fingers, into the ignition control other than the vehicle key. Objects other than the vehicle key may cause the ignition control unit to fail.

⚠ In extreme low temperatures (-20°C and below) do not allow the engine to 'rev' above 4000 rpm, while at standstill or when moving off, until the coolant temperature gauge reaches normal operating temperature. Revving the engine before fully warmed up may cause severe engine and transaxle damage.

⚠ Do not press the vehicle key while driving. If the key is pressed in and released the engine will stop. If the key is removed from the ignition control while driving the engine will stop but the steering lock will not engage until the vehicle has come to a complete stop.

⚠ The vehicle key must only be inserted into the ignition control with the two indents first, as shown. Attempting to insert the larger end first the key may damage the ignition control.



📖 Make sure that you are wearing appropriate footwear to efficiently operate the control pedals. Make sure that pedal movement is not restricted by floor mats or other objects trapped beneath pedals.

Ignition Sequence

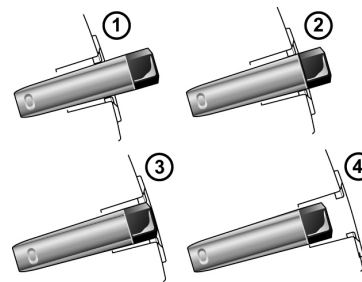

[1] : Position '0' (Ignition OFF)

[2] : Position 'I' (Ignition OFF and Accessories ON)

[3] : Position 'II' (Ignition ON)

[4] : Engine start

Engine Start

Check that the park brake is applied.

Fully press the brake pedal down.

Insert the vehicle key into the ignition control and press the key fully in (the ignition control will show red), hold in until the engine starts then release.

The vehicle key will sit flush with the ignition control bezel while the engine is running. The ignition control will show a white light when the engine is running, and then fade out.

 *When starting the engine the vehicle system will take short time (approximately one second) to complete a system check and release the steering lock before allowing the engine to crank.*

If the engine fails to start, release the key, then press the key fully in again **without the brake pedal pressed down** and release. The key will gently return to position '1'. Start the engine start procedure again.

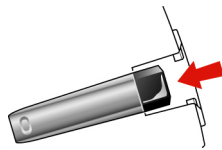

Starting From Cold

The Engine Control Module (ECM) automatically compensates for cold or warm start conditions and makes appropriate adjustments to the fuel and air mixture and ignition timing.

Stopping the Engine

Press the vehicle key fully in and release. The engine will stop as the key returns to position '1'. Withdraw the vehicle key from the ignition control.

Maximum Engine Speed

The maximum safe engine speed is 6,850 rpm. If this speed is exceeded, fuel supply to the engine is reduced. As the engine speed reduces back to a safe level, fuel supply is progressively restored.



Automatic Transmission

The Automatic transmission has two drive modes.

Auto Drive Mode

In auto drive mode gearshifts are made using the Park, Reverse, Neutral and Drive (PRND) buttons mounted on the centre stack. While driving forward gearshifts are made automatically according to various driving parameters, i.e. road speed, current selected gear and accelerator demands. When the vehicle is stationary the transmission will select first gear, ready to move off immediately when the accelerator is pressed.

While in auto drive mode move to touchtronic mode at any time by pulling back on either the upshift or downshift gearshift paddles, mounted behind the steering wheel. As a paddle is pulled back a gearshift will occur, this will be an upshift or downshift according to which paddle is pulled.

Kick-Down

In auto drive mode kick-down is used in circumstances where rapid acceleration is required, i.e. when overtaking. Kick-down operates when the accelerator pedal is quickly and fully depressed, causing the transmission to change down to the lowest gear possible to achieve maximum acceleration. The gear engaged depends on the road speed at the time of kick-down.

Touchtronic Mode

In touchtronic mode forward gears and Neutral are selected by using the paddles located behind the steering wheel. Reverse and park selected by using the PRND buttons.

While in touchtronic mode move to auto drive mode at any time by pressing the **DRIVE** button.

 Neutral can also be selected by pressing the **NEUTRAL** button.

PRND Buttons



[1] PARK: Press and release to select park once the vehicle is stationary. The transmission will mechanically lock. If the vehicle key is moved to position '0' or removed from the ignition control while the vehicle is at a standstill, the transmission will automatically select park.

 **Always make sure that the park brake is ON.**

 It is not possible to select Park above 2 km/h.

[2] REVERSE: When stationary and with the footbrake applied, press and release to select Reverse. When reverse is selected, **R** will show red in the Gear Position Indicator Display (GPID) (B) and a warning will be heard.

[3] NEUTRAL: When stationary and with the footbrake applied, press and release to select Neutral.

[4] DRIVE: When stationary and with the footbrake applied, press and release to select forward gears.

 If the brake pedal is not pressed the message centre (right) will show **PRESS BRAKE PEDAL** and a warning will be heard.

The message centre (left) (A) shows the current gear selection R, D1, D2, etc., while the Gear Position Indicator Display (GPID) (B) shows D (Drive), R (Reverse) or P (Park) according to current gear position. While in auto drive mode the GPID will show 'auto'.

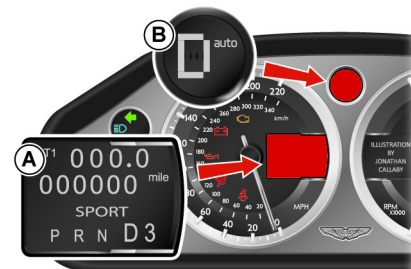

Vehicle Rocking Motion

If the vehicle speed is less than 4 km/h, reverse may be selected from drive, without pressing the brake pedal, to create a vehicle 'rocking' motion i.e. to enable vehicle movement out of mud, snow, etc. If 4 km/h is exceeded then the transmission will automatically select Neutral.

Touchtronic Controls

Forward gearshifts are selected by pulling back and releasing the gearshift paddles mounted on the steering column. Neutral is selected by pulling back both paddles together and releasing. Park and reverse are selected by using the centre stack mounted PRND buttons.

[1] : Downshift paddle.

[2] : Upshift paddle.

 *Neutral can also be selected by pressing N.*

From park, reverse or neutral, and with the footbrake applied, pull back on either the upshift or downshift gearshift paddle to enter touchtronic mode. As the vehicle speed increases and decreases, make upshifts and downshifts by pulling and releasing the upshift or downshift gearshift paddle.

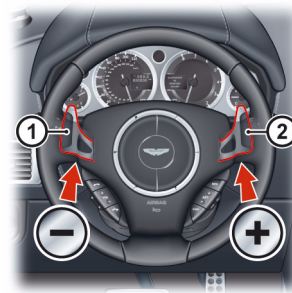

If no gearshift has been requested by pulling back on a paddle, upshifts and downshifts will occur automatically if the engine speed rises or lowers to its maximum or minimum operating limits (unless the transmission is in sport mode (Refer to 'Sport Mode', page 5.6)). When stationary select neutral by pulling back on both gearshift paddles simultaneously. When selecting neutral from park the brake pedal must be depressed.

The message centre (left) shows the actual gear currently selected R, D1, D2, etc. The GPID also shows the current gear selected but may show the target gear when a gearshift is in progress (either 1, 2, 3, 4, 5, 6, R or P). The GPID will show 'touch'.



Sport Mode

Sport mode can be selected while in auto drive or touchtronic modes. Press and release the Sport button (A) to enter or exit sport mode. The Sport button LED will come ON and SPORT will show in the message centre (left) when sport mode is ON.



When Sport mode is ON while in:

Auto Mode: Upshifts and downshifts occur at higher engine speeds to provide a sportier drive.

 *If sport mode is selected while in auto drive sixth gear a downshift to fifth gear will occur (this will not happen if cruise control is ON) and sixth gear will be inhibited until sport mode is set to OFF.*

Touchtronic Mode: Automatic upshifts are prevented, the upshift paddle must be pulled back and released to make an upshift (downshifts will occur automatically if the engine speed lowers to its minimum operating limits).

To maintain speed and smoothness while driving in touchtronic sport mode, the current gear, shown in the GPID, will flash red at the optimum time to make an upshift.

 *To protect the engine and transmission, when in touchtronic mode, an automatic upshift from fifth to sixth gear will occur when the engine speed reaches 6600 rpm.*



Fault Conditions

Limp-home Mode

If a fault is detected the vehicle will go into one of three limp home modes:

Electrical: GEARBOX FAULT REDUCED FUNCTION will show in the message centre (right). Touchtronic and sport modes will be disabled. Gearshifts will still be possible but shift quality will be degraded.

 *In certain circumstances forward drive will be restricted to a fixed gear.*

Contact your Aston Martin Dealer.

Reduced Engine Performance: REDUCED ENGINE PERFORMANCE will show in the message centre (right). Engine performance will be restricted. Contact your Aston Martin Dealer.

Mechanical: LIMPHOME NO GEAR CHANGE POSSIBLE will show in the message centre (right) and a warning sound will be heard. If travelling forwards in auto drive or touchtronic mode the vehicle will go into a locked gear (third or fifth depending on vehicle speed).

⚠ Do not attempt to change gear position while in mechanical limp home mode. If a gearshift request is detected at a speed below 20 km/h the engine will stop and the parklock will come ON.

⚠ At a speed above 20 km/h the request and any other transmission request will be rejected and the vehicle will continue in third or fifth gear.

If entering mechanical limp home mode in any position other than auto drive or touchtronic mode the parklock will come ON (Refer to 'Parklock Override', page 11.16). Contact your Aston Martin Dealer.

Footbrake

The footbrake operates through a vacuum boosted, dual (diagonal split) circuit, hydraulic system incorporating an Anti-lock Brake System (ABS).

⚠ Warning: In the event of a brake failure bring the vehicle to a halt as soon as it is safe to do so. Do not continue to drive.

⚠ If vacuum boost fails or one circuit fails the footbrake will still operate but with greater pedal pressure, increased pedal travel and longer stopping distances.

⚠ After a long drive over salted or gritted roads or if driving in heavy rain, through water or a vehicle wash, the braking action may be delayed and increased braking pressure may be required.

 Vacuum boost is only available while the engine is running.

Ceramic Brake Discs

⚠ Warning: Track day use and high speed driving: For track use or high speed driving new brake pads must be subject to specific conditioning. Failure to correctly condition the pads may result in greatly reduced brake performance. Contact you Aston Martin Dealer.

Carbon ceramic brake systems combine low weight with high performance, offering:

- Reduced unsprung weight (mass of components not supported by the suspension) - improving vehicle handling
- Improved rate of wear characteristics
- Improved braking performance

 The rate of wear of the brake pads and discs will depend on driving style and usage conditions. Track day usage will increase the rate of wear of discs and pads.

Brake Warnings

⚠ Warning: *If the brake warning symbol comes ON, you should immediately be prepared for possible increased stopping distances and possible partial failure of the braking system.*

While driving, if the brake warning symbol  comes ON, it shows either that:

- The park brake is not fully released
- The brake pads require regular maintenance
- The brake fluid level has fallen below an acceptable level
- The Electronic Brake Distribution (EBD) system has stopped working.

 A warning message will show in the message centre (right).

Stop, as soon as possible in a safe and convenient place. Apply the footbrake and make sure that the park brake is fully released. If the park brake is fully released and the warning symbol stays ON, **do not drive** the vehicle. Contact the nearest Aston Martin Dealer. It is essential that the brake system is checked immediately, preferably by an Aston Martin Dealer.

 *Brake Noise: The high performance brake system used on this vehicle is designed to provide optimal braking under all operating conditions. However, under all driving conditions an inherent characteristic of this braking system is some brake noise. Certain combinations of speed, braking forces and ambient conditions may also cause the brakes to squeal.*

Anti-Lock Braking System

The Anti-lock Braking System (ABS) helps prevent the road wheels from locking and skidding during emergency braking. This also assists the driver in maintaining steering and directional stability.

If, in an emergency braking situation, the braking force applied begins to exceed the tyre to road adhesion, the ABS operates to prevent the road wheels locking. When this happens a pulsating effect is felt through the brake pedal. This is a normal ABS effect.

Safety

In all cases it is always the drivers responsibility to drive safely according to the law and with due regard to prevailing conditions. The fact that a vehicle is equipped with ABS must never let the driver to be tempted into taking risks which could affect his or her safety or that of other road users.

The addition of ABS cannot overcome the consequences of trying to stop in too short a distance, cornering at too high a speed, or the risk of aquaplaning (where the tyres are prevented from contacting the road surface by a layer of water).

The driver should always take road conditions into account. A slippery road surface always requires more braking distance for a given speed, even with ABS. Possible extensions of stopping distance compared to locked wheels may occur during ABS operation on slushy snow, gravel, sand or certain heavily corrugated or ridged warning sections of road surfaces.

If any braking system malfunction occurs, immediately have the Braking and ABS systems checked by your Aston Martin Dealer.

ABS Warning

⚠ Warning: If the ABS warning symbol comes ON, you should be aware that wheels could lock during extreme braking or when braking on slippery surfaces.

ABS is monitored for correct operation while the ignition is ON. If a fault is detected, the ABS warning symbol  will come ON and the ABS will be partly or fully OFF. Normal braking will continue to function without ABS.

In the event of an ABS fault, consult your Aston Martin Dealer immediately.

Dynamic Stability Control

⚠ Warning: It is the drivers responsibility to drive safely according to the law and with due regard to prevailing conditions.

⚠ Warning: Dynamic Stability Control (DSC) must never let the driver be tempted into taking risks which could affect his or her safety or that of other road users. DSC cannot overcome consequences of applying too much engine power for prevailing conditions.

Dynamic Stability Control (DSC) is a system designed to enhance driving safety by improving the vehicle handling when the tyres are at the limits of their grip capabilities. This is achieved through the reduction of engine torque and strategic application of the brakes at individual wheels.

Driver Interface and Control

⚠ If repair or replacement of the steering or other surrounding equipment is necessary, always refer to your Aston Martin Dealer. If the centre position of the steering deviates, the DSC system may not operate correctly because there is a sensor in the steering system which detects steering wheel position.

⚠ The DSC system may not operate correctly when using tyre chains or a temporary spare tyre.

⚠ Use tyres of the same manufacturer, brand, tread pattern and correct size specified for this vehicle on all four road wheels. Do not mix worn tyres.

DSC has three modes of operation:

ON: The DSC system sets to ON each time the engine is started. DSC is controlling engine torque and applying strategic application of the brakes at individual wheels.

While the DSC system operates to correct the vehicle stability the DSC symbol , on the instrument cluster, will flash.



TRACK MODE: Press and hold the DSC button (A) for four seconds and release. DSC TRACK MODE SELECTED will show in the message centre (right). This raises the thresholds at which the DSC system operates. While the DSC system operates to correct the vehicle stability the DSC symbol will flash.

OFF: When in track mode press and hold the DSC button for four seconds and release to set the DSC to OFF. DSC OFF can not be selected from DSC on. DSC FUNCTION OFF will show in the message centre (right). DSC is no longer controlling engine torque and applying strategic application of the brakes at individual wheels.

At any time while in track or off mode, press and release the DSC button to start DSC.

 The DSC button LED and the DSC symbol (instrument cluster) will come ON when the system is set to track or off mode.

Fault Signs

A malfunction in the DSC control system will be shown by the following:

- The DSC symbol in the instrument cluster will come ON
- A warning message will show in the message centre (right) depending on the fault detected

Traction Control

 **Warning:** It is always the drivers responsibility to drive safely according to the law and with due regard to prevailing conditions.

 **Warning:** Traction control must never let the driver be tempted into taking risks which could affect his or her safety or that of other road users.

 **Warning:** Traction control cannot overcome consequences of applying too much engine power for prevailing conditions.

Traction control is a function of DSC, and is operated in association with the DSC system. Traction control prevents excessive wheel spin at standing starts, or during acceleration. Wheel spin is usually caused by excessive use of the accelerator pedal, or slippery, loose or bumpy road surfaces.

To prevent excessive wheel spin and maintain vehicle stability in such situations the traction control system will:

- Brake either of the driven wheels when they start to slip
- And, or, adapt the engine torque to a level corresponding to the traction available on the road surface

 *These symptoms are normal and will clear as wheel spin is eliminated and normal engine power is restored.*

 *If cruise control is on it will automatically go OFF when traction control is operating.*

During operation, the DSC warning symbol will flash. The driver may experience a loss in power or temporary 'misfire' as engine power is reduced.

If traction control cuts in when driving on extended icy or slippery surfaces, reduce engine power as necessary until the DSC warning symbol goes OFF.

Traction control is always ON when DSC is ON.

Adaptive Damping

The Adaptive Damping System (ADS) is continuously ON, adjusting the damping characteristics at all four corners, according to vehicle body movement and monitored driver inputs. Sensors on the vehicle constantly measure the vehicle body movement and driver inputs – braking, steering, vehicle speed and throttle displacement. This information is then supplied to the ADS control unit which calculates the optimal damper characteristic at each corner at any given moment.

 *ADS is independent of the DSC system.*

ADS has two modes of operation:

Normal Mode: At ignition ON the ADS system defaults to normal mode which gives damping characteristics for everyday driving.



Sport Mode: Press and release the ADS button (A) to start sport mode, which gives damping characteristics for a firmer ride.

While driving move to normal (button LED OFF) or sport (button LED ON) mode by pressing and releasing the ADS button.

Park Brake

⚠ **Always fully apply the park brake before leaving the vehicle.**

To apply the park brake: Press the footbrake pedal firmly down. Keep the pedal pressed down and pull the park brake lever up until resistance is felt. At this point depress the park brake button and continue to pull the park brake lever up to its fullest extent. Release the button and allow the lever to lower.



📖 *To show that the park brake is applied the brake warning symbol on the instrument cluster will come ON (if the ignition is ON).*

To release the park brake: Press the footbrake pedal firmly down. Keep the pedal pressed down and pull the park brake lever up until resistance is felt. Pull up against the resistance and depress the release button. Keep the button depressed and push the lever down. If the park brake lever is not fully OFF, the brake warning symbol will stay ON.

⚠ **Always check that the brake warning symbol is OFF before moving off. Do not attempt to drive the vehicle if the brake warning symbol stays ON.**

📖 *An audible warning will sound if the vehicle is moving and the park brake is still applied.*

- If the vehicle is parked on a hill and facing uphill, select first gear and turn the steering wheel away from the kerb
- If the vehicle is parked on a hill and facing downhill, select reverse gear and turn the steering wheel towards the kerb

Fuel Filling

📖 *The fuel tank filler neck has a restricted opening which will only accept the fuel supply nozzle of unleaded fuel pumps.*

Open the fuel flap by pressing the fuel flap release button (A (located in the driver's footwell)). If the filler flap will not open when the release button is pressed, use the fuel filler flap emergency release.

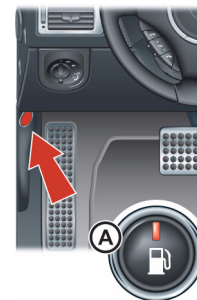

Turn the cap counterclockwise past resistance, then lift off. Place the cap into its holder. Install the cap by turning clockwise past resistance, until three 'clicks' are felt as the cap is fully tightened. Close and latch the fuel flap.

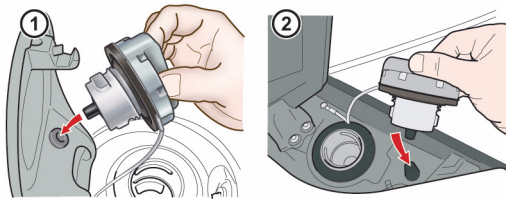

[1] : Coupe

[2] : Volante

The fuel system will not let the fuel tank overfill but there will be times when the fuel nozzle will shut OFF prematurely. If this happens only try to fill the fuel tank one more time, continued attempts will result in fuel spillage. Wait 10 seconds before removing the refuelling nozzle.

Fuel Filler Bowl

To stop water gathering in the fuel filler bowl and flowing into the fuel tank, the fuel filler bowl has a pipe to let the water drain from the bowl. During fuel filling, check and make sure that any debris which may block the pipe is removed.

Fuel Filler Flap Emergency Release

If the filler flap will not open when the release button is pressed, open the filler flap manually. Reach through the left side boot trim to access the manual fuel filler flap release. Pull the lever (B) to open the filler flap.

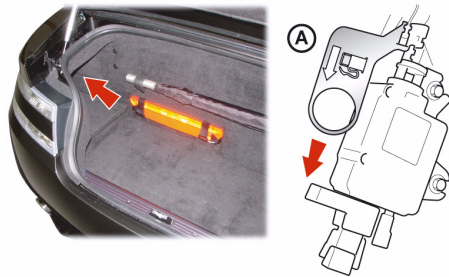

Fuel Cut-OFF

In the event of a vehicle accident the vehicle electronics will enter crash mode. Power to the fuel pumps will stop, thereby reducing fire risk.

Engine Oil Level

⚠ It is important to check the engine oil level regularly. Running the engine with engine oil below the lower mark or above the upper mark can cause serious engine damage.

Check the engine oil level every fourth fuel tank fill or weekly - whichever ever is the sooner.

Catalytic Converters

⚠ Warning: Do not park over dry grass, leaves or other combustible material. Significant fire risk exists because of residual heat in the catalytic converters.

⚠ Warning: Do not drive through deep water. Rapid cooling of catalysts may cause them to break up.

Catalytic converters convert harmful exhaust gasses into less noxious substances and so reduce environmental pollution. They operate at high temperatures and continue to radiate a considerable amount of heat after the ignition has been set to OFF.

Leaded fuel will cause irreparable damage to catalytic converters. If leaded fuel is inadvertently added to the fuel tank **do not start the engine, do not drive the vehicle.** Contact your Aston Martin Dealer immediately.

Front and Rear Parking Assist

⚠ Warning: Parking assist does not replace need for total vigilance and caution when parking or reversing.

⚠ It is always the driver's responsibility to detect obstacles and estimate the vehicle's distance from them. Some overhanging objects, barriers, thin obstructions or painted surfaces which could possibly cause damage to the vehicle may not be detected by the system. Always be vigilant when reversing.

⚠ The rear sensors are not ON when neutral is selected, therefore care should be taken if moving the vehicle as the warning sound will not be heard.

⚠ Do not clean the sensors with abrasive or sharp objects.

📖 For reliable operation, the sensors in the front and rear bumpers should be kept free from ice, frost and grime.

📖 When using a high pressure spray the sensors should only be sprayed briefly and not from a distance of less than 200 mm. Do not clean the sensors with abrasive materials.

A warning will be heard when driving forwards or rearwards, if objects are detected within range of the vehicle.

Operation

⚠ If, for example, you are driving within a confined space such as a home garage, the outer sensors will detect the side walls and after three seconds the tone will stop. However, as movement continues, the inner sensors will eventually detect the rear wall and will start the tone again.



⚠ In heavy rain or similar adverse conditions, the rear parking assist sensors may not always be able to accurately measure distance to close objects. A fully laden vehicle or irregular obstacles may also cause inaccurate measurements.

The parking assist system defaults to OFF when the ignition is set to ON. The system comes ON when reverse gear is selected, or if the parking assist button (A) is pressed at speeds below 15 km/h.

The system will set to OFF when the vehicle moves forwards above 15 km/h. The parking assist button LED will come ON when the system is set to ON. The LED will flash if a fault is detected in the system.

If an obstacle is detected at the front or rear of the vehicle, a series of beeps will be heard from the front or rear speaker respectively, which increases in rate as the vehicle nears the obstacle.



The beep becomes a continuous tone when an obstacle is detected at or within approximately 300 mm from the rear or 250 mm from the front of the vehicle.

If the system has a fault a single three second tone will be heard (only once per ignition cycle) and the parking assist button LED will blink when reverse gear is selected or the ignition is set to ON. The system is automatically disabled when a fault is detected.

 Parking assist may sound spurious tones if it detects an ultrasonic frequency using the same band as the sensors.

 The system consists of inner and outer sensors. When manoeuvring forward into a garage, etc., the front outer sensors will cease detection if they detect a stationary or receding object for three seconds or more, this allows detection directly at the front of the vehicle in this type of manoeuvre.

Rear Only Parking Assist

Option

⚠ Warning: Rear parking assist does not replace need for total vigilance and caution when parking or reversing.

⚠ When parking or reversing make full use of rearward vision and all mirrors to be aware of persons or objects in the vicinity of the vehicle. Take appropriate measures to protect them from danger.

⚠ In heavy rain or similar adverse conditions, the rear parking assist sensors may not always be able to accurately measure distance to close objects. A fully laden vehicle or irregular obstacles may also cause inaccurate measurements.

Rear parking assist assists in detecting obstructions as the vehicle is reversed towards them. The system is ON when reverse gear is selected. When the system is operating an intermittent 'beep' signal will be heard. The 'beep' frequency increases in pitch and persistence as the vehicle reverses to an obstruction.



 The 'beeps' start at approximately 1.7 m from any obstruction. The 'beep' becomes continuous at distances less than 30 cm.

 If reversing into a confined area, i.e. a home garage, the rear parking assist outer sensors will detect the side walls and, after 3 seconds, the 'Beep' sequence will stop. As reversing continues the rear parking assist inner sensors will detect the rear wall or obstruction and the 'beep' sequence will start again.

Set parking assist to OFF by pressing the parking assist button (A) if required (button LED OFF). For reliable operation, the parking sensors should be kept free from ice, frost and grime.



Driving Techniques

Procedures for driving this vehicle may be unfamiliar to many new owners. To make sure that you have a safe and enjoyable entry into this new phase of Aston Martin motoring please take time to safely acquire the necessary new driving skills. Practise in safe, lower speed conditions before investigating the high performance potential of the vehicle.

Performance Driving Courses are available to enable customers not only to understand the control functions of their vehicle but also the basic principles of Performance Driving.

Contact your Aston Martin Dealer for further information.

Wet Conditions

When driving in wet conditions, water can build up under your tyres so that they ride on a layer of water. This is called aquaplaning or hydroplaning. When this happens, you have little or no control.

Aquaplaning is more prone to happening at higher road speeds if there is a lot of water on the road and particularly if the tyres are also under inflated or approaching minimum tread depth.

It is important to take bends or curves at a safe, reasonable speed, particularly when driving on wet or slippery road surfaces.

Slow down when it is raining.

Track Days

Before using this vehicle on track days contact your Aston Martin Dealer for vehicle set up, service parts and recommendations.

Driving Through Deep Water

⚠ *If in any doubt whether to drive through deep water, always take the side of caution to avoid potentially costly damage to the vehicle's engine or other essential systems.*

If driving on flooded roads, through deep or standing water is unavoidable, proceed with extreme caution, especially when the depth is not known. Never drive in water deeper than the lower edge of the front bumper. Water can be splashed up into the engine air intakes located in the front upper grille and cause extensive damage to the engine or the vehicle may stall.

When driving through water, traction or brake capability may be limited. Once through the water, always dry the brakes by driving slowly while applying light pressure on the brake pedal.

 *Waves caused by other vehicles or natural causes can also splash water in the engine air intakes.*

Running-In

This vehicle is fully hot tested during manufacture and no special running-in procedures are necessary. Nevertheless it is recommended to limit engine loads (e.g. by accelerating gently and by using lower gears on steep hills or when negotiating tight turns) during the first 1500 km.



ASTON MARTIN



ASTON MARTIN



ASTON MARTIN



ASTON MARTIN

Climate Control

Operating Tips	6.2
Climate Controls	6.2
Airflow Modes.....	6.5
Automatic Operation	6.6
Manual Operation.....	6.7



Operating Tips

- A solar sensor is installed on top of the instrument panel, this should not be covered when driving
- The intake grille of the in-vehicle temperature sensor is located in the driver's knee bolster, close to the centre console. To maintain the optimum temperature this grille should not be obstructed
- Moisture which forms on the evaporator in the air conditioning unit is discharged via a drain tube onto the road. After stopping, small puddles of water may form underneath the vehicle. This is normal and does not show a system malfunction
- Operate the climate control system with the engine operating
- Clear all obstructions like leaves, snow and ice from the bonnet and the air inlet in the front grille to improve the system efficiency
- Windows can fog up easily in humid weather. Use the climate control system to demist the windows
- To help demist the windows, operate the air conditioner to dehumidify the air
- Use the 'outside air' position in normal conditions. The 'recirculated air' position should be used temporarily when driving on dusty roads or for quick cooling or heating of the interior

- If the vehicle has been parked in direct sunlight during hot weather, open the windows to let warm air escape, then close the windows and operate the climate control system
- Operate the climate control system at least once a month to keep internal parts lubricated
- Have the climate control system checked before the weather gets hot. If the climate control system is low on refrigerant or has a malfunction, consult your Aston Martin Dealer
- This vehicle is equipped with a pollen filter. It is necessary to change the filter periodically as shown in the scheduled maintenance. Consult your Aston Martin Dealer
- Air conditioning may not function when the outside temperature approaches 0°C (indicator stays ON even when system is OFF).

Climate Controls

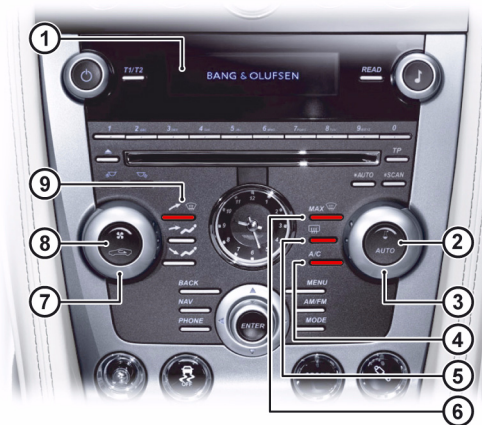

[1] **DISPLAY:** Shows options, menus and information.

[2] **AUTO:** Press for automatic climate control operation (Refer to 'Automatic Operation', page 6.6).

[3] **TEMPERATURE:** Set the required in vehicle temperature. Turn clockwise for hot and counterclockwise for cold. The selected temperature is shown on the **DISPLAY**.

[4] **A/C:** When in manual mode press and release to set the air conditioning ON or OFF.

[5] **HEATED REAR WINDOW:** Press to operate the rear window heater. Goes OFF after 20 minutes if not manually set to OFF. When the heated rear window is ON the door mirror heaters will work for 6.5 minutes, then go OFF.

[6] **MAX** : Press for maximum defrost or demist ON or OFF. Outside air intake is automatically selected and air conditioning is automatically started.

 **Warning:** Do not select recirculated air in cold or rainy weather, it can cause the interior glass to mist up.

[7] **FAN SPEED:** Turn to set the required fan speed (clockwise for fast speed and counterclockwise for low speed). The fan speed is shown on the **DISPLAY**

[8] **AIR CIRCULATION:** Controls the source of air entering the vehicle. Press to select recirculated air (button LED ON). Press again to select outside air as source.

Use the recirculated air position when going through tunnels, driving in congested traffic (high engine exhaust areas) or when maximum cooling is required. On start up the default position is outside air as source. Use this position for normal conditions and demisting.

[9] **AIRFLOW:** Select the required airflow. The selected air flow mode is shown on the **DISPLAY**(Refer to 'Automatic Operation', page 6.6).

Display Units

To change the **DISPLAY** units from °C to °F or °F to °C.

Press and hold in buttons 1 and 6 (A). Insert the vehicle key in the ignition control and move to position 'II' (ignition ON), then release the two buttons.



Solar and Temperature Sensors

The automatic air conditioner function measures inside and outside temperatures, and sunlight. It then sets the interior temperature accordingly. To maintain effective operation do not obscure the following sensors:

[1] : Solar sensor.

[2] : In-vehicle temperature sensor.

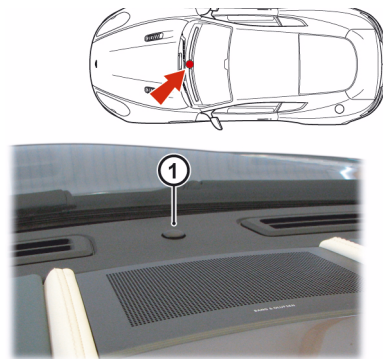

Airflow Modes

Press and release each button for an airflow mode. By pressing one or more buttons at a time, five airflow modes are available.

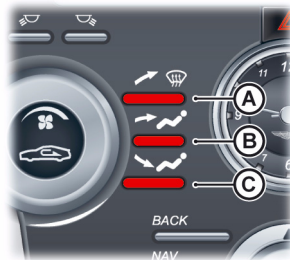

Mode	Button(s)
Windscreen and Door Windows ¹	A
Face Only	B
Feet Only ²	C
Windscreen, Door Windows and Feet ³	A+C
Face and Feet	B+C

1. In addition a small bleed of air is directed into the face vents.
2. In addition a small bleed of air is directed to the face vents, the windscreen and door windows.
3. In addition a small bleed of air is directed into the face vents.



Adjusting the Vents

To adjust the air flow vents:

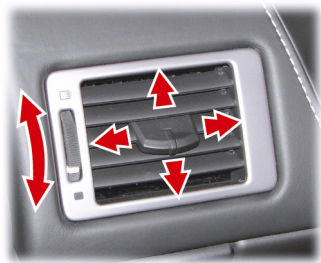



Automatic Operation

Press **AUTO**. Using the **TEMPERATURE** dial set the required in-vehicle temperature (read the actual temperature setting in the top left of the **DISPLAY**). The **A/C** button LED will come ON.

Adjustments to fan speed, air flow and air re circulation will be made automatically according to the set temperature, interior and exterior conditions.

 *Maximum fan speed will not be available until the engine has reach its normal operating temperature.*

 *When using the air conditioner, mist may come out from the vents. This is not a sign of trouble but a result of humid air being suddenly cooled.*

 *If resetting climate control functions other than the fan speed, the fan speed will stay set as in automatic mode. Adjustments to the fan speed will cancel Auto Mode.*

Defrost and Demist

 **To defrost or demist the windscreen on vehicle start up in extreme cold weather conditions, operate the engine at 1500 rpm. Always make sure that the transmission is in P (park) and the park brake is applied.**

Press **MAX** . The outside air intake is automatically selected, the temperature is set to maximum and air conditioning is started.

 *If the engine is cold the air conditioner will not start up until the engine has started to warm up.*

To cancel automatic defrost or demist either:

- Press **MAX**  again
- or
- Press **AUTO**
- or
- Press any of the airflow mode buttons

Manual Operation

Set the required:

- Fan speed
- Temperature
- Air flow

 The fan speed and temperature setting will show on the **DISPLAY**.

 When using the air conditioner, mist may come out from the vents. This is not a sign of trouble but a result of humid air being suddenly cooled.

 Setting the temperature to maximum high or low will not provide the required temperature at a faster rate. To prevent cool air blowing from the vents when heating immediately after starting a cold engine, the amount of airflow is reduced until the air warms up.

 The vehicle heater will continue to produce the selected temperature regardless of in-vehicle conditions.

If dehumidifying is required, press the **A/C** button (button LED ON). To stop dehumidifying press **A/C** button (button LED OFF).

When maximum cooling is required, set the **TEMPERATURE** dial to the extreme cold position and press the **AIR CIRCULATION** button to the re circulated air position ( will show in the **DISPLAY**), then set a fast fan speed.

Defrost and Demist

 **To defrost or demist the windscreen on vehicle start up in extreme cold weather conditions, operate the engine at 1500 rpm. Always make sure that the transmission is in P (park) and the park brake is applied.**

Press **A/C**. Press the   airflow button.

Set the required:

- Temperature
- Fan speed

 If the engine is cold the air conditioning will not start up until the engine has started to warm up.

 For maximum defrost or demist set the temperature and fan speed dials to maximum.



ASTON MARTIN



ASTON MARTIN



ASTON MARTIN



ASTON MARTIN



Convertible Roof

Roof Operation	7.2
Conditions for Operating the Roof.....	7.2
Door Windows Reset	7.5
Manual Raise and Lock	7.5
Roof Maintenance.....	7.7
Deployable Rollbars	7.8
Wind Deflector	7.9

Roof Operation

⚠ Warning: Before raising or lowering the roof, make sure that all occupants are clear of the roof linkage, the windscreen frame and door windows.

⚠ Warning: Misuse of the roof switch, especially by children, can result in injury due to entrapment in the roof mechanism and locking points.

! Make sure that the roof is always fully raised or fully lowered.

! Avoid repetitive use of the roof; this may cause the roof pump to over heat. If the pump over heats roof movement will be inhibited until the pump has cooled.

! Do not attempt to lower the roof if any objects or clothing are laying on top of the roof.

! Before closing or opening the roof, make sure that there are no objects placed on the rear sloping deck area which could interfere with the folded, stored roof, especially the heated rear windscreen glass. Even small objects can cause damage.

! Continuous use of the roof without the engine operating will cause the vehicle battery to rapidly discharge.

! Do not store objects or items in the roof storage area. Any objects or items stored there may cause damage to the roof when attempting to lower it. Even small objects can cause damage.

 Due to wind pressure when driving at very high speeds the door windows may not close correctly.

Conditions for Operating the Roof

⚠ Warning: Keep the vehicle road speed down to a minimum until the roof has completed its operation.

! Aston Martin recommend that the roof is only operated while the vehicle is stationary.

- The boot lid must be closed
- The ignition must be ON (engine running or not)
- Headroom (A (1531 mm)) is available for the roof to raise or lower
- Outside temperature must be above -10°C

 The boot lid will lock and will stay locked during roof lowering and raising operations.



If the vehicle is moving while the roof is being raised or lowered, roof movement will continue, while the roof switch is pressed, until the roof has locked in the raised or lowered position. While operating the roof the following warnings will show, depending on the vehicle speed:

4 to 5 km/h: STOP SAFELY FOR ROOF OPERATION will show in the message centre (right).

5 to 65 km/h: STOP SAFELY FOR ROOF OPERATION will show in the message centre (right), the amber warning triangle will show and a single audible warning will sound. Roof movement will continue.

Over 65 km/h: ROOF FAILURE POSSIBLE will show in the message centre (right), the amber warning triangle will show and a continuous audible warning will sound. Roof movement will continue.

It is not possible to start roof operation at speeds of 50 km/h or above. NO ROOF OPERATION POSSIBLE will show in the message centre (right), the amber warning triangle will show and a single audible warning will sound. While operating the roof, if the roof switch is released when travelling at 50 km/h or more, no roof movement will be available until the vehicle speed drops below 50 km/h.

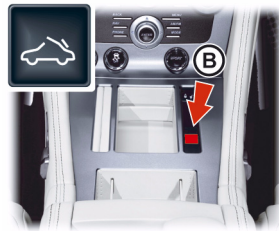

The roof operation switch (B) is located on the centre console. If at any time during the lowering or raising procedure the switch is released – the roof will stop immediately. ROOF MOVEMENT PAUSED will show in the message centre (right) and an audible warning will sound until the roof continues to raise or lower.

If at any time during the lowering or raising procedure the switch is released – roof movement will stop immediately. ROOF MOVEMENT PAUSED will show in the message centre (right) and a continuous audible warning will sound until the roof continues to lower or raise.

! As soon as it is safe to do so continue the roof movement. If the roof is left in pause for ten minutes, hydraulic pressure will be lost. The roof and tonneau lid will relax and, gently, fall back. Powered roof operation will be stopped until the roof has been manually fully raised or lowered.

Lowering the Roof

⚠ Warning: Roof movement has not finished and locked until ROOF MOVEMENT COMPLETE shows in the message centre (right).

Pull the roof switch rearwards and hold until ROOF MOVEMENT COMPLETE shows in the message centre (right).

If the door and rear quarter windows are required to be lowered, continue to press the switch after ROOF MOVEMENT COMPLETE shows, until the windows have fully lowered.



Raising the Roof

⚠ Warning: Roof movement has not finished and locked until ROOF MOVEMENT COMPLETE shows in the message centre (right).

Push the roof switch forwards and hold until ROOF MOVEMENT COMPLETE shows in the message centre (right) and a single audible warning sounds.

If the door and rear quarter windows are required to be raised continue to press the switch after ROOF MOVEMENT COMPLETE shows until the door windows have fully raised.



Rear Quarter Windows

The rear quarter windows can be lowered and raised independently of the roof. When the roof is fully lowered or raised use the roof switch to lowered and raised the rear quarter windows:

Roof Fully Lowered: Push and hold the roof switch to lower or raise the rear quarter windows. Release the switch when the window movement has stopped.

Roof Fully Raised: Pull back and hold the roof switch to lower or raise the rear quarter windows. Release the switch when the window movement has stopped.

Door Windows Reset

In the unlikely event of the roof failing while in the fully raised or lowered position, check for correct operation of the vehicle door windows.

To check the door windows operation use the door window reset procedure (Refer to 'Door Window Reset', page 11.28). Once correct operation of the windows is confirmed, check roof operation again. If the roof will not work then manually raise and lock the roof (if required) and contact your Aston Martin Dealer.

Manual Raise and Lock

In the unlikely event of the roof failing during raising or lowering, it can be manually raised and locked, if required.

⚠ Warning: Aston Martin recommend that a minimum of two people are required to manually raise and lock the roof. The roof mechanism is heavy and will move very slowly when being raised manually.

⚠ Warning: Keep fingers clear of the roof linkage when moving the roof manually.

⚠ Vehicle Security: If the roof fails always raise and lock the roof. Do not lower the roof. Tonneau lid locks will not be available.

 If the roof fails in the stored position it can stay stored and locked if required. Contact your Aston Martin dealer.

 If the roof fails after the tonneau locks have been released the message ROOF FAIL will show in the message centre (right) and a continuous audible warning will sound until the roof has been locked in the raised position.

If installed, remove and store the wind deflector(Refer to 'Wind Deflector', page 7.9).

Remove the allen key from the vehicle tool kit (A) and place in the vehicle cabin.

 The allen key is required to lock the roof in position.

Remove the vehicle key and wait for a minimum of five seconds.

 During this time the roof hydraulics will relax allowing manual movement of the roof. Some hydraulic fluid resistance will still be in the operating rams. It may take considerable effort to fully raise the roof manually.

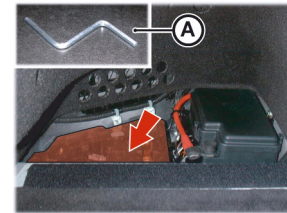

Close the Roof Manually: If the Tonneau Lid is Closed with the Roof on Top

Manually raise the roof to the fully closed position.

! Make sure that the hook on the last roof joint engages correctly on both sides.

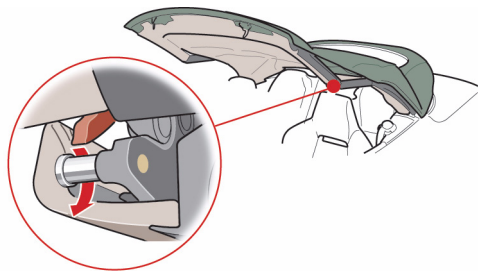

Remove the trim plug.

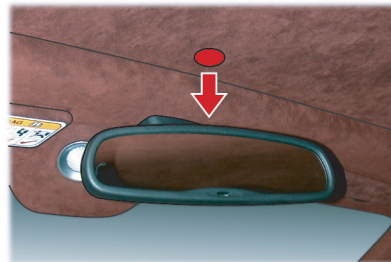

Make sure the two lock arms are located in their catches.

! Locking the roof manually may require the assistance of a second person to push down so the catches engage while the allen key is turned.

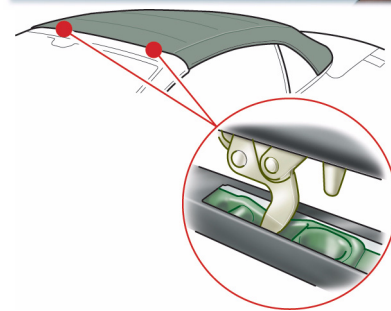

Use the allen key to lock the roof in position. Continue to turn the allen key until no more movement is possible.

! Do not use power tools. The roof manual lock and unlock mechanism may be damaged if power tools, i.e. an electric drill, are used to lock or unlock the roof.

! Many turns of the allen key will be required to lock the roof.

ROOF MOVEMENT PAUSED will show in the message centre (right) and a continuous 'beep' will sound until the roof has been locked.

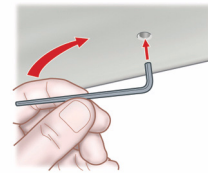

Close the Roof Manually: If the Tonneau Lid has Unlocked and the Roof is Underneath

⚠ Do not allow the tonneau lid to rest on the roof fabric.

Manually lift the tonneau lid. Continue to hold the tonneau lid while closing the roof. When the roof rear has cleared the tonneau lid, let the tonneau lid slowly fall to close. Slowly raise the roof to meet the top of the windscreen. The rear of the roof will lay in position on the edge of the tonneau lid.

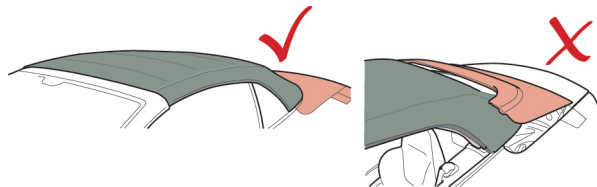

Rear Quarter Windows

Depending on the reason why the roof fails, the rear quarter windows may not raise when raising the roof manually. When the roof has been manually raised and locked, set the ignition to ON and attempt to raise the rear quarter windows by operating the roof close switch.



Roof Maintenance

⚠ Do not use automatic vehicle washes. Brushes, detergents and pressurised water jets may damage the roof fabric.

⚠ Do not use power washers. Jets of water may damage the weather seals and the roof fabric.

⚠ Do not use spot cleaners, chemical diluents or any organic cleaners. If in doubt, contact your Aston Martin Dealer.

If the roof is left for prolonged periods in the lowered position (folded), in certain circumstances (a wet or dirty roof) permanent soiling along folds may occur in the roof fabric. Do not leave the roof in the lowered (folded) position for longer than necessary.

Roof Fabric Maintenance

(Refer to 'Convertible Roof Fabric', page 11.37)

Deployable Rollbars

⚠ Warning: Do not attempt to service or modify the deployable rollbar system.

⚠ Warning: Do not allow any person to sit on the deployable rollbar covers at any time.

⚠ Warning: Do not place any objects on the top of the deployable rollbar covers.

⚠ Warning: Do not attempt to reset the deployable rollbar system after it has deployed.

⚠ Warning: Do not attempt to raise or lower the roof after the deployable rollbar system has deployed.

⚠ If the roof is raised the deployable rollbars will break through the rear glass.

⚠ Extreme manoeuvres may cause the system to predict a roll over and deploy the rollbars for protection of the occupants. If such driving events are anticipated by the customer (e.g. Track day driving) the roof should be fully lowered to let the rollbars to deploy without damaging the vehicle.

📖 The deployable rollbar system and the airbag system react independently. The deployable rollbars and the airbags may deploy together or alone, depending on the type of impact.

The Volante is equipped with a deployable rollbar system, which is in addition to and independent of the airbag system.

The deployable rollbar system comprises an electronic roll sensor unit integrated into the main crash sensor and two 'U' shaped roll bars, concealed behind the rear seat, which will deploy in the unlikely event of the vehicle rolling over. The electronic roll sensor constantly monitors vehicle movement.

On sensing an impending roll over situation the electronic roll sensor sends a signal to the deployable rollbars, triggering a release. The deployable rollbars then extend upward and lock into place.

If the deployable rollbar system has been deployed, contact your nearest Aston Martin Dealer.



Warning Labels



Wind Deflector

A wind deflector can be installed to enhance comfort when driving with the roof lowered:

- Wind turbulence is greatly reduced
- It easily installs to existing mounts within your vehicle
- The wind deflector can be left in place with the roof raised or lowered
- Easily folded and stowed away when not used

⚠ Take care when adjusting the driver or passenger seat position with the wind deflector installed. Make sure that the seats do not come into contact the wind deflector.

Storage

When the wind deflector is not required, remove it from the vehicle and place it in its storage bag. Place the storage bag in the vehicle boot.

When the wind deflector is not required, remove it from the vehicle and place it in its storage bag. The bag is secured to the back wall of the boot at four location points.

Install and Remove

Remove the deflector from its storage bag.

Make sure that the location pins are retracted. If not retracted pull the pins back and twist (left or right) to lock.

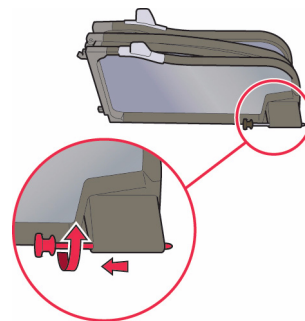

Unfold.

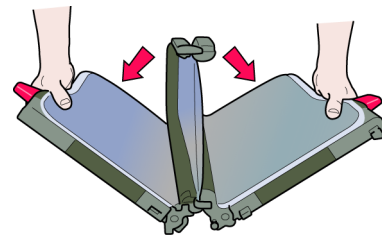

Open out and 'snap' connect.

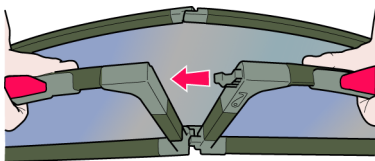

Locate the two tabs in to the openings provided in the rear seat backs.



With the tabs located line up the location pins and locate the two locking pins either side in the openings provided. Twist the pins (left or right) to release and make sure they locate correctly.

Remove the wind deflector from the vehicle by reversing the procedure to install.



Lowered Position

Grab the top of the raised section and lower until a locating 'click' is heard.



Raised Position

Grab the rear of the top section and pull upwards (90°) until a locating 'click' is heard.

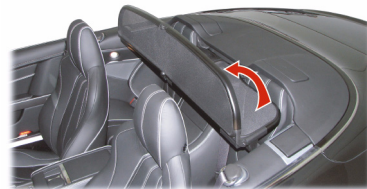



Audio

Audio Essentials.....	8.2
Audio Controls	8.4
Radio Functions	8.8
Radio Data System	8.9
Programme Type.....	8.10
Enhanced Other Networks	8.11
Automatic Frequency Updating.....	8.11
Regional.....	8.11
CD Changer Functions	8.12
iPod and USB Functions.....	8.13
Auxiliary Functions	8.14
Audio Menus	8.14

Audio Essentials

Aston Martin Audio

Standard

Radio: AM and FM radio. 10 AM and 20 FM presets are available.

CD: Six CD autochanger.

iPod₁: Connection port.

USB Device: Connection port.

Auxiliary Input: Connection port.

Power Output: 700W.

Surround Sound: Dolby Pro-Logic II.

Speakers

[1] : 100W centre-fill speaker.

[2] : Two door-mounted 100W speakers, each with mid-range and tweeter units.

[3] : Two rear environment 100W speakers, each with mid-range and tweeter units.

[4] : 200W subwoofer housed under the rear environment left side.

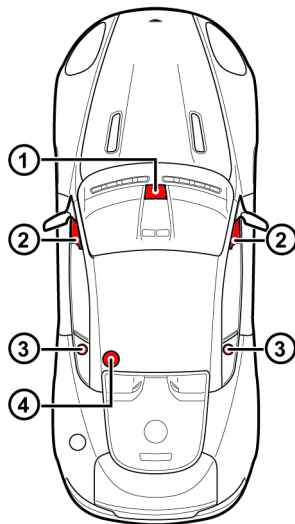

Bang & Olufsen Audio

Option

Radio: AM and FM radio. 10 AM and 20 FM presets are available.

USB Device: Connection port.

Auxiliary Input: Connection port.

Power Output: 974W

¹ iPod is a trademark of Apple Inc.

Speakers

[1] : Two 19 mm (soft dome) tweeters incorporating Acoustic Lens Technology (ALT).

[2] : Centre: Two speakers: One 90 mm mid-range in closed cabinet and one 19 mm (soft dome) tweeter.

[3] : Footwell: Two 140 mm woofers in closed cabinets.

[4] : One 90 mm mid-range speaker, in closed cabinets, in each front door.

[5] : One 200 mm subwoofer housed in closed cabinet under the rear environment left seat.

[6] : Two speakers: One 90 mm mid-range and one 19 mm (soft dome) tweeter in each rear quarter.

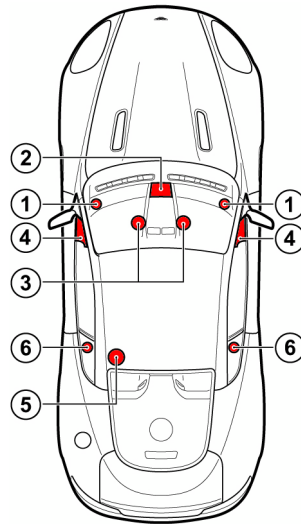

Acoustic Lens Technology

Acoustic Lens Technology (ALT) gives a wide (180°) horizontal dispersion of high frequencies. This prevents the loss of critical sound and gives listeners an improved sense of space, staging and realism, even when not sitting in the optimal location¹ for listening to two-channel stereo reproductions.



Two motorised acoustic lenses, mounted on either side of the dashboard, rise when the system is set to ON and stay raised until the audio system is set to OFF.

¹. For the optimal location to listen to two-channel stereo reproductions, the listener should be sitting equidistant from both loudspeakers on the apex of an equilateral triangle.

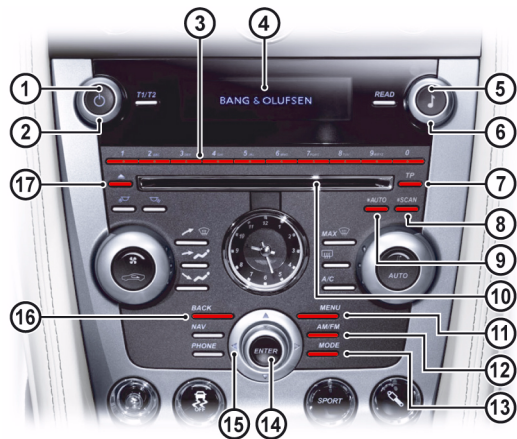

[1] **ON/OFF:** Press for audio ON and OFF.

[2] **VOLUME:** Volume control.

[3] **KEYPAD:** Use the numbers as menu short cuts. Press the number corresponding to the menu number.

[4] **DISPLAY:** Shows options, menus and information.

[5] **SOUND:** Press and hold to enter sound setting mode. Press repeatedly to move through settings, turn to select. When in iPod or USB mode a press and release will enable file viewing.

[6] **TUNING:** Turn to manually search stations, change music tracks or navigate in the menus.

[7] **TP:** Press to enable traffic broadcasts. Press again to disable.

[8] **SCAN:**

- **Radio:** Find and store the strongest stations.
- **CD's, iPod / USB:** 10 seconds of each track is played. Press once again to select a track.

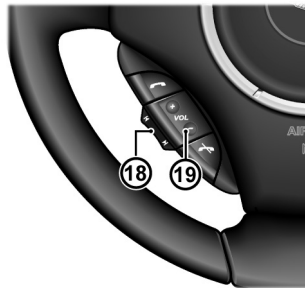

[9] **AUTO:** Automatic station search.

[10] **CD OPENING:** Insert CD's

[11] **MENU:** Opens the main menu.

[12] **AM/FM:** Press to select radio as audio source.

[13] **MODE:** Press repeatedly to select audio source.

[14] **ENTER:** Select in the menu, open a selection or open a file.

[15] **JOYSTICK:** Navigate in the menus.

- **Radio:** Press left or right to auto search the next station. Press and hold left or right to manually select a station. Press up or down to navigate in the menus or preset stations.
- **CD's:** Press left or right to move to the next or previous track. Press left or right and hold to search within a track or the whole CD. The search continues as long as the Joystick is pressed.
- **iPod / USB:** Press left or right to move to the next track or previous. Press left or right and hold to search within a track or the whole music folder. The search continues as long as the Joystick is pressed.

[16] **BACK:** Press to move back one action. Press and hold to move back to the default screen.

[17] CD EJECT:

[18] SCROLL:

- **Radio:** Navigate through the preset radio stations.
- **CD's, iPod / USB:** Navigate through the music tracks.

[19] VOLUME: Volume control.

Operation

The audio system is available with the vehicle key at least in position '1' and is available until the vehicle key is removed from the ignition control.

If the audio system is ON when the ignition is set to OFF and the vehicle key removed, it will automatically start the next time the vehicle key is moved to position '1'.

Press **ON/OFF** to set the audio system ON or OFF.

 *When the audio system is set to ON the volume will be at the same level it was when the audio system was set to OFF.*

The **JOYSTICK**, **ENTER** and **BACK** will not operate if Satellite Navigation is selected (**NAV** button LED ON) either press:

- The **NAV** button to deselect satellite navigation (**NAV** button LED OFF)
- Or press any audio button other than **BACK**, **ENTER** and **JOYSTICK**

to access controls for audio.

 *Pressing the **AM/FM** or **MODE** buttons will move the current audio source.*

Sound Source

To select radio, at any time while the audio system is ON, press the **AM/FM** button repeatedly to navigate between the radio bands.

To select other audio sound sources press the **MODE** button repeatedly to navigate through the sound source choices.

Battery Protection Mode

Using the audio system, with the vehicle key at position '1' (ignition OFF) will drain the battery charge. A warning message will show in the message centre (right) when the battery charge is low (Refer to 'Battery Protection Mode', page 11.20).

Menus

The audio menu is only available when the audio system is in use. Press **MENU** to access the main menu. The menu for the current audio source (i.e. radio, CD, iPod, etc.) will be available.

Search Path

Menu paths are shown for each operation in the following format:
<FM Menu...> Enter <Sound settings...> Enter

Several menu options will require a cross in a box to select an option. Once the menu item is highlighted press **ENTER** to either check or uncheck the box. Then press and hold **BACK** to accept and return to the main screen.

 *In this chapter when asked to 'Press' a button, this means 'Press and release'. When this is not the case it will be clear in the text.*

Active Sound Control

This vehicle has a speed-dependent volume feature known as Active Sound Control (ASC). This adjusts the volume automatically depending on the speed of the vehicle.

Press **MENU** and navigate to sound source menu, press **ENTER**. Select <Auto. volume control> Enter <Off>, <Low>, <Optimum> or <High> Enter.

Original Settings

Radio Functions

Resets all radio settings to the original factory settings: Press **MENU** and navigate to <FM Menu...> Enter <Advanced radio settings...> Enter <Reset all...> Enter. Press **ENTER** again to confirm.

Sound Settings

Resets all sound settings to the original factory settings: Press **MENU** and navigate to sound source menu, press **ENTER**. Select <Audio settings...> Enter <Reset all...> Enter. Press **ENTER** again to confirm.

Aston Martin Audio Sound Settings

To access sound settings press and hold **SOUND** to enter sound setting mode. Then press repeatedly until the required sound setting is shown on the **DISPLAY**. Turn the **TUNING** dial to the desired setting.

 The level for the centre speaker can only be set if either Dolby Pro-Logic II or 3 Channel has been selected from the sound source menu.

Bass: Level for bass

Treble: Level for treble

Fader: Balance between the front and rear speakers

Balance: Balance between the left and right speakers

Surround: Level for surround sound

Subwoofer: Level for subwoofer

Centre: Level for centre speaker

Surround: Level for surround sound

Setting the Surround Sound

Press **MENU** and navigate to the sound source menu, press **ENTER**. Select <Audio Settings...> Enter <Surround (AM, FM, CD iPod or AUX)...> Enter <Dolby Pro-Logic II>, <3 Channel> or <Off> Enter. Press and hold **BACK** to return to the main display. The symbol for Dolby Pro-Logic II is shown on the **DISPLAY** if Dolby Pro-Logic II is selected. '3CH' is shown on the **DISPLAY** if 3 Channel is selected. 'Off' means the system is in normal stereo mode. Dolby Pro-Logic II is not available in radio mode.

Equaliser

Fine adjustment of the sound from the speakers: Press **MENU** and navigate to the sound source menu, press **ENTER**. Select <Audio Settings...> Enter <Equaliser...> Enter. Move the **JOYSTICK** left or right to set the level. Use the **JOYSTICK** (up or down) to select the next frequency. Five frequencies can be adjusted. Press **ENTER** to save any changes and exit. Press **BACK** to exit without saving any changes.

Dolby Surround Pro-Logic II

Dolby Surround Pro-Logic II, with its centre speaker in the dashboard, provides more realistic sound reproduction.

The normal left and right stereo channels are divided into left-centre-right. In addition, ambient surround sound is produced through the rear speaker channels.

Not available in Radio mode.

 *Dolby Surround Pro-Logic II and the Dolby icon are trade-marks of Dolby Laboratories Licensing Corporation. The Dolby Pro-Logic II Surround System is manufactured under license from Dolby Laboratories Licensing Corporation.*



Bang & Olufsen Audio Sound Settings

To access sound settings press and hold **SOUND**. Then press repeatedly until the required sound setting is shown on the **DISPLAY**. Turn the **TUNING** dial to the desired setting.

Sound Focus

The focus of the sound from the audio system can be optimised for either the driver or the driver and front passenger. Select:

 *The audio system detects seat occupancy by seat belt engagement.*

Driver: The focus of the sound is optimised for the driver only.

Front: The focus of the sound is optimised for both the driver and the front passenger.

Auto: Other Sound Settings

Bass: Level for bass

Treble: Level for treble

Fader: Balance between the front and rear speakers

Balance: Balance between the left and right speakers

Surround: Level for surround sound

Radio Functions

Automatic Tuning

Select FM1, FM2 or AM using the **AM/FM** button. Press the **JOYSTICK** (left or right) to search for the next strong station.

Press left or right again to start a new search.

 *If no stations are found press either button again to cancel.*

Manual Tuning

There are two ways to tune into a station manually.

- Turn the **TUNING** dial to set the desired frequency.
- Press and hold the **JOYSTICK** (left or right).
The frequency rolls slowly in the selected direction and increases speed after a few seconds.

Release the button when the desired frequency shows on the **DISPLAY**. If the frequency needs adjusting, briefly touch one of the arrows.

Storing Stations

10 stations can be stored for FM1, FM2 or AM (a total of 30 stations).

To store stations:

Tune to the desired station. Press and hold the **KEYPAD** button (0-9) where the station is to be stored. The sound will be muted for a couple of seconds and 'Station Stored' will show on the **DISPLAY**.

Select a stored station by either pressing a **KEYPAD** (0 to 9) button or use the **SCROLL** button to scroll through the station list.

Autostoring Stations

Up to ten AM or FM stations can be automatically tuned and stored in a separate memory.

Select FM1, FM2 or AM using the **AM/FM** button. Start the search by pressing and holding **AUTO** (more than two seconds).

'Autostoring.' shows on the **DISPLAY** and a number of strong stations (maximum ten) from the selected frequency band are stored in the autostore memory. If there are no stations that are sufficiently strong, 'No AST Found' shows on the **DISPLAY**.

 *If more than ten stations are found, the ten strongest are selected. This function is particularly useful if you are in an area in which you are unfamiliar with the radio stations and their frequencies.*

The stations are stored on the **KEYPAD** (buttons 0-9). When the radio is in autostore mode, 'Autostoring' is shown on the **DISPLAY**.

Return to the ordinary radio mode by pressing and releasing **AUTO** (less than 0.7 seconds). Pressing and releasing either **AUTO** or **BACK** will also cancel autostoring.

Select an Auto stored station by pressing **AUTO**, then a **KEYPAD** (0 to 9) button or the **SCROLL** button to scroll through the station list.

Automatic Search for Transmitter

'PI seek' shows on the **DISPLAY** when reception is poor for the selected station. The radio automatically searches for the strongest transmission for that station. 'PI seek Back to cancel' is shown on the **DISPLAY** until the station is found.

Scanning

Scanning automatically searches for the next strong FM or AM station signals. When the radio finds a station, scanning pauses for approximately eight seconds, after which it continues.

Select FM or AM with the **AM/FM** button.

Press **SCAN**. 'Scan' shows on the **DISPLAY** and each found station will play for approximately eight seconds. Press **SCAN** or **BACK** to accept the station.

 *If no stations are found press either button again to cancel.*

Radio Data System

Radio Data System (RDS) is a system that links together specific network transmitters. It is used, for example, to tune the correct frequency of a station irrespective of the transmitter or the current audio source (e.g. CD). The system can also be used for receiving traffic information (TP) and for finding broadcasts of a specific type. Radio text is also a component of RDS. A radio station can transmit information about the radio programme currently being broadcast.

Messages with a programme code (such as news from RDS stations) will interrupt other audio sources at the volume set for this. As soon as the news broadcast is finished, the audio system returns to the previous audio source and resumes the previous volume setting.

 *Some radio stations do not use RDS or only use a limited range of its features.*

Alarm

Alarms are transmitted automatically. The function cannot be set to OFF. 'Alarm!' is shown on the **DISPLAY** when an alarm message is broadcast. The function is used to warn motorists of serious accidents or disasters.

News

Press **MENU**. Navigate to <FM Menu...> Enter <News> Enter. When news is ON 'NEWS' will show on the **DISPLAY**.

Press **BACK** during a news broadcast to cancel the broadcast. The news function stays ON and waits for the next news programme.

News From Current Station

Press **MENU**. Navigate to <FM Menu...> Enter <Advanced Radio Settings...> Enter <News station...> Enter <News from current station> Enter.

Traffic Information (TP)

Press **TP** repeatedly to set TP ON and OFF.

When ON 'TP' is shown on the **DISPLAY**. If the set station does not broadcast traffic information, 'TP)))' shows on the **DISPLAY**.

Press **BACK** to exit the current traffic broadcast. TP stays ON and waits for the next traffic broadcast.

TP From a Station or All Stations

Press **MENU**. Navigate to <FM Menu...> Enter <Advanced radio settings...> Enter <TP...> Enter <TP station...> Enter <TP from current station> or <TP from all stations> Enter.

TP Search

This function allows you to listen to traffic information when travelling between different areas and countries without selecting a station.

Press **MENU**. Navigate to <FM Menu...> Enter <Advanced radio settings...> Enter <TP...> Enter <TP search> Enter.

Radio Text

Some RDS stations broadcast information, such as about programme content and artists.

Press **MENU**. Navigate to <FM Menu...> Enter <Radio text> Enter.

Programme Type

Use the Programme Type (PTY) function to select between the various programme types.

Press **MENU**. Navigate to <FM Menu...> Enter <PTY...> Enter <Show PTY> Enter.

When ON the station's programme type will be shown on the **DISPLAY**, e.g. Current affairs, Information, Drama, Rock music, etc.

 Not all radio stations have a PTY designation.

Searching for a Specific PTY

Press **MENU**. Navigate to <FM Menu...> Enter <PTY...> Enter <PTY...>. Press **ENTER** for one or more of the listed programme types.

The PTY symbol on the **DISPLAY** comes ON when the first selection is made and the radio is set to stand-by for PTY.

Press **BACK** to go back.

Navigate to <FM Menu...> Enter <PTY...> Enter <Search PTY> Enter.

If the radio finds a station with the selected programme type, this is played.

If a station with the selected programme type can not be found, the **DISPLAY** shows 'No Station Found' and the radio returns to the previous frequency.

PTY is then on stand-by until the selected programme type is broadcast. When this happens, the radio automatically selects the station broadcasting the programme type.

Clear All PTY

Press **MENU**. Navigate to <FM Menu...> Enter <PTY...> Enter <Clear all PTY...> Enter.

The PTY symbol is removed from the **DISPLAY** and the radio returns to normal mode.

Enhanced Other Networks

With Enhanced Other Networks (EON) ON, traffic announcements and news broadcasts interrupt radio programmes. The function has three levels:

Local: Only interrupts if the signal is strong.

Distant: Interrupts even if the signal is weak.

Off: Does not interrupt even if the signal is weak.

EON - ON or OFF

Press **MENU**. Navigate to <FM Menu...> Enter <Advanced radio settings...> Enter <EON...> Enter. Select <Local>, <Distant> or <Off> Enter.

When ON 'EON' is shown on the **DISPLAY**.

Automatic Frequency Updating

The Automatic Frequency (AF) Updating function is normally ON and makes sure that the radio tunes to the strongest available transmitter.

Press **MENU**. Navigate to <FM Menu...> Enter <Advanced radio settings...> Enter <AF> Enter.

When ON 'AF' is shown on the **DISPLAY**.

Regional

The regional function is normally OFF. When the function is ON you can continue to listen to a regional broadcasts even if the signal is weak.

Press **MENU**. Navigate to <FM Menu...> Enter <Advanced radio settings...> Enter <Regional> Enter.

When ON 'Reg' is shown on the **DISPLAY**.

CD Changer Functions

Loading CDs

⚠ *Use only 12 cm. CDs. Do not use CDs with adhesive disc labels. The heat from the CD player can cause the label to come loose from the disc. The CD player could be damaged.*

⚠ *Do not use CDs that are warped or look warped (critical measurement for CD warp is 0.7 mm - anything more than this may cause problems). The CD player will not be able to hold the CD correctly (because of the warp), this may cause a jam in the CD player.*

📖 *If the quality of the CD does not comply with the requirements of standard EN60908 or if it has been recorded using poor equipment, sound quality may be poor or playback interrupted.*

The CD changer can hold up to six discs.

Press the **MODE** button repeatedly to select CD. Select an empty position using the **KEYPAD** (buttons 1 to 6) or use the **JOYSTICK** (up or down). The **DISPLAY** shows which positions are empty. Make sure that 'Insert disc' is shown then insert a new disc.

Selecting a CD

Select the CD to play using **KEYPAD** buttons 1-6 or the **JOYSTICK** (up or down). The number of the disc and track are shown on the **DISPLAY**.

Changing Tracks

Press the **JOYSTICK** (left or right), the **SCROLL** button, or turn the **TUNING** dial to play the next or previous track. The track number is shown on the **DISPLAY**.

Fast Forward and Rewind

Press and hold the **JOYSTICK** (left or right) to search forwards or backwards within a track or the whole disc. Searching continues for as long as the button is depressed.

Random Play

Plays tracks from a CD or CDs in random order.

Press **MENU**> Navigate to <CD Menu...> **Enter** <Random...> **Enter**. Select <Off>, <Single disc> or <All discs> **Enter** for the player to randomly choose from none, one or all CDs.

RND or RND ALL is shown on the **DISPLAY** while the function is ON. Press the **JOYSTICK** (left or right) or **SCROLL** button to select the next or previous random track.

Press **BACK** to cancel random play.

Scan

Press **SCAN** to play the first ten seconds of each track. While a scan is in progress press **SCAN** again or **BACK** to play a track.

Pause Mode

When the volume is at zero, play will pause. Start play again by turning the volume up.

Disc Text - ON or OFF

Some CDs have title information. The information is shown as text on the **DISPLAY**.

Press **MENU**. Navigate to <CD Menu...> **Enter** <Disc text> **Enter**.

If information is stored on the disc, this is shown on the **DISPLAY**.

Ejecting one CD

Press **EJECT**.

 For traffic safety reasons, the CD stays out for 12 seconds. The player will then draw back in the disc and set to pause mode. Press CD to start the player.

Ejecting all CDs

Press and hold **EJECT** (for longer than two seconds). The entire magazine is emptied, CD by CD. 'Eject all' is shown on the **DISPLAY**.

This function can only be used when the vehicle is stationary and is interrupted if the vehicle starts to move. For traffic safety reasons, the ejected CD stays out for 12 seconds. It must then be removed, or the function is cancelled.

iPod and USB Functions

iPod and USB Connection

 The iPod port is compatible with generation three iPods onwards.

 The USB port is only compatible with USB storage devices, e.g. Memory Sticks.

 On initial connection and on every engine start the system will synchronise with the connected device. This will take a short while to complete.

 The iPod controls will not operate while connected to the vehicle audio system. All functionality will be from the vehicle audio system.

Locate the iPod cable or the USB socket in the armrest cubby box and connect the:

- iPod player cable to the iPod cable
- USB device to the USB port

If not already ON, set the audio system to ON. Repeatedly press the **MODE** button until either 'iPod' or 'USB' shows on the **DISPLAY**.

The iPod or USB device can now be operated by the audio system.

Playing Tracks

Once the mode has been set to either iPod or USB play automatically starts.

Selecting Tracks

Press **ENTER** to show the music folder list. Using the **JOYSTICK** (up or down) or the **TUNING** dial navigate through the folder list or music tracks. Press **ENTER** to open a folder or play a track.

Pause Mode

When the volume is at zero, play will pause. Start play by turning the volume up.

Fast Forward and Rewind

Press and hold the **JOYSTICK** (left or right) to search within a track or the whole music folder. The search continues as long as the **JOYSTICK** is held.

Changing Tracks

Press the **JOYSTICK** (left or right), or the **SCROLL** button, or turn the **TUNING** dial to play the next or previous track.

Scan

Press **SCAN** to play the first ten seconds of each track. While a scan is in progress press **SCAN** again or **BACK** to play the required track.

Random

Plays tracks from the music folder(s) in random order.

Press **MENU**. Navigate to <iPod Menu...> or <USB Menu...> Enter <Random...> Enter. Select <Off>, <Folder> or <All> Enter for the player to randomly choose from none, one or all music folders.

'RND' or 'RND ALL' is shown in the **DISPLAY** while the function is ON.

Press the **JOYSTICK** (left or right) or the **SCROLL** button to select the next or previous random track.

RDS Radio stations

News broadcasts (NEWS) and traffic information (TP) are also available when in USB or iPod mode. Refer to iPod and USB menus.

Auxiliary Functions

Audio Device Connection

The auxiliary input socket is provided to connect audio devices which can not be connected using the iPod or USB connections.

 *Only volume control will be available from the vehicle audio system. All other functionality will be from the audio device.*

Locate the auxiliary socket in the front armrest cubby box. Connect the audio device to the auxiliary socket using a suitable cable.

If not already ON, set the audio system to ON. Repeatedly press the **MODE** button until AUX shows on the **DISPLAY**.

The media device will now play through Infotainment system.

Audio Device Volume

The vehicle audio system volume can be set at a higher or lower starting volume for the audio device.

Press **MENU**> Navigate to <AUX menu...> Enter <AUX input volume...> Enter. Turn the **TUNING** dial to set the volume level.

Press and hold **BACK** to return to the main display.

Audio Menus

Radio Menu

1) FM Menu...

- 1) News
- 2) PTY...
 - 1) Select PTY...
 - 2) Search PTY
 - 1) Clear all PTY...
 - 2) Select PTY station
 - 3) Show PTY (ON or OFF)
- 3) Radio text
- 4) Advanced Radio Settings...
 - 1) TP...
 - 1) TP station...
 - 2) TP search
 - 2) News station...
 - 3) AF
 - 4) Regional
 - 5) EON...
 - 6) Reset all...
- 5) Sound settings...
- 6) Auto. volume control...

2) AM Menu...

- 1) Sound settings...
- 2) Auto. volume control...

CD Changer Menu

1) CD Menu...

- 1) Play list
- 2) Random...
 - 1) Off
 - 2) Single disc
 - 3) All discs
- 3) News
- 4) Disc text
- 5) Auto. volume control...

iPod and USB Menu

1) iPod Menu... or USB Menu...

- 1) Playlist...
- 2) Random...
 - 1) Off
 - 2) Folder
 - 3) All
- 3) News
- 4) Track Information
- 5) Sound settings...
- 6) Auto. volume control...

Auxiliary Menu

1) AUX Menu...

- 1) AUX input volume...
- 2) News
- 3) Sound settings...
- 4) Auto. volume control...



ASTON MARTIN



ASTON MARTIN



ASTON MARTIN



ASTON MARTIN

Hands-Free Phone

Hands-Free Functions	9.2
Hands-Free Functions	9.2
Connecting a Phone.....	9.4
Disconnecting a Phone.....	9.4
Pairing Phones	9.5
Selecting a Phone.....	9.6
Using a Phone.....	9.7
Phone Book	9.8
Voice Mailbox.....	9.8
Last Ten Numbers	9.9
Hands-Free Menu	9.9

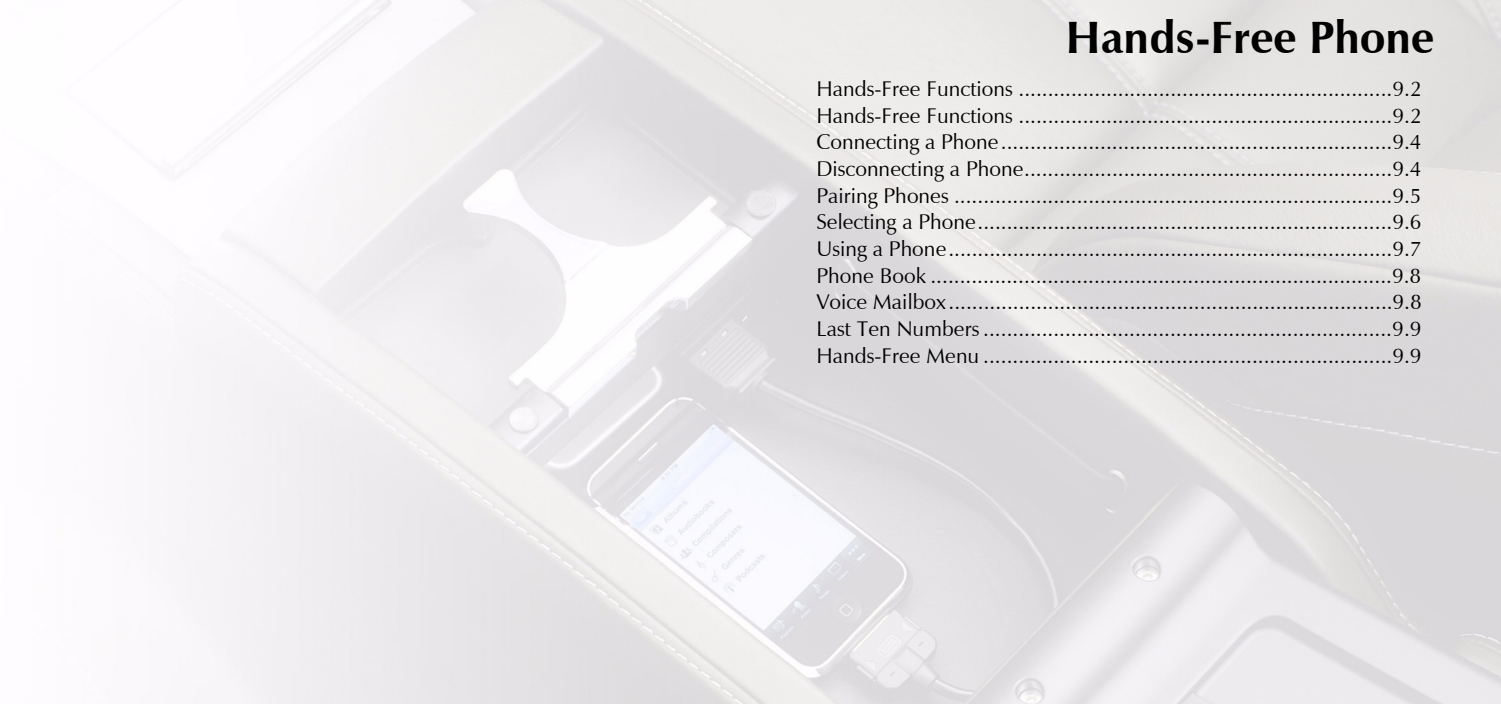

Hands-Free Functions

A mobile device equipped with hands-free (Bluetooth) capability can be connected wirelessly to the vehicle's hands-free phone system. The vehicle's hands-free phone system then lets you have remote control of a range of the mobile phone's functions. The mobile phone can always be operated by its own keys regardless of whether or not it is connected.

 *The hands-free phone system uses the internal antenna of the mobile phone. Placing the mobile phone in the trinket tray may degrade the hands-free system performance.*

The hands-free phone system will not recognise a mobile phone, even if it is 'paired' (Refer to 'Pairing Phones', page 9.5), if the mobile phone does not have Bluetooth enabled. For more information refer to the user's guide for your mobile phone.

The hands-free phone system does not support SMS (text messages).

Hands-Free Functions



[1] VOLUME: Volume control.

[2] DISPLAY: Shows options, menus and information.

[3] TUNING: Navigate through phone book and menus.

[4] MENU: Opens the main menu.

[5] ENTER: Press to answer or make a call, select in the menu or open a selection.

[6] JOYSTICK: Navigate in the menus, move forwards or backwards when entering text and digits.

[7] PHONE: Press to select hands-free mode or press and hold to cancel hands-free mode.

[8] BACK: End a call, navigate back in the menu, cancel a selection or erase the previous character when entering text and numbers.

[9] KEYPAD: Search through the phone book, speed dial or navigate in the menu.

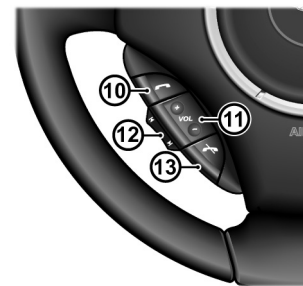



[10] CALL: Press to answer a call or press to return to hands-free mode from audio when hands-free mode is ON.

[11] VOLUME: Volume control during a call.

[12] SCROLL: Navigate in the menus.

[13] CANCEL: Press to end a call or press to enter audio mode when hands-free mode is selected./P

Hands-Free Phone ON

When the hands-free system is ON the  symbol will show in the **DISPLAY**. During a call this symbol will change to . When

a mobile phone is connected to the hands-free system the  symbol will show in the **DISPLAY**. If, after 30 seconds, the hands-free phone has not been used, the infotainment system will default to audio functions. Return to hands-free phone functions by pressing **PHONE** or **CALL**.

Menus

The hands-free menu is available when the hands-free phone system is ON and selected. If not ON or not selected press **PHONE**. Press **MENU** to access the main menu.

Search Path

Menu paths are shown for each operation in the following format:
<Phone menu...> (Enter) <Phone settings...> (Enter) <Sounds and volume...>

 *In this chapter when asked to 'Press' a button, this means 'Press and release'. When this is not the case it will be clear in the text.*

Several menu options will require a cross in a box to select an option. Once the menu item is highlighted press **ENTER** to either check or uncheck the box. Then press and hold **BACK** to accept and return to the main screen.

Call Menu

Press **MENU**, **ENTER** or **CALL** during an ongoing call to access the following functions:

Mute microphone: The hands-free system microphone is muted.

Transfer call to mobile or Transfer call to vehicle: The call can be transferred to or from the mobile phone or the vehicle phone.

Phone book: Access the phone book during a call.

 *Some mobile phones will close the connection when the privacy function is used, this is normal. The vehicle system asks if you want to reconnect.*

Audio Settings

Call Volume

During a call the call volume can be regulated using the **VOLUME** dial or button.

Audio System Volume

The audio source can be automatically muted for incoming calls: Press **MENU** and navigate to <Phone menu...> (Enter) <Phone settings...> (Enter) <Sounds and volume...> (Enter) <Mute radio> (Enter).

If mute radio is OFF select one of the audio sources to control the audio system volume during an ongoing call.

Audio System Control

Not available during a call.

When the audio system is in operation while hands-free mode is ON press **CALL** to return to hands-free mode.

Ring Volume

Press **MENU** and navigate to <Phone menu...> (Enter) <Phone settings...> (Enter) <Sounds and volume...> (Enter) <Ring volume> (Enter). Adjust using the **TUNING** dial.

Ring Signals

The vehicle system has integrated ring signals that can be selected:

Press **MENU** and navigate to <Phone menu...> (Enter) <Phone settings...> (Enter) <Sounds and volume...> (Enter) <Ring signal> (Enter) <Select Ring signal 1, 2, 3 etc.> (Enter).

 *The connected mobile phone's ring signal is not muted when one of the vehicles integrated signals is used.*

Connecting a Phone

A connection between the vehicle hands-free system and a mobile phone is called a 'Paired Link'. When a paired link is set up the hands-free system remembers the mobile phone's ID.

Once the hands-free system and the mobile phone are paired, the hands-free system automatically connects every time the ignition is set to ON if the hands-free system (Press **PHONE**) and the mobile phone are ON.

A mobile phone can be paired either using the vehicle hands-free system or by using the mobile phone.

This system supports paired links with up to five phones.

 *The process of initiating a hands-free connection with a phone varies per phone manufacturer. For more information refer to the user's guide for your mobile phone.*

Disconnecting a Phone

The mobile phone will **automatically** disconnect when moved out of the Hand-Free system's range or bluetooth is made unavailable on the mobile phone.

The mobile phone will **manually** disconnect when the hands-free system is set to OFF. Press and hold **PHONE** until  is removed from the **DISPLAY**. The function is also stopped when the ignition is set to OFF.

If the mobile phone has been disconnected from the hand-free system during an ongoing call, the call will transfer to the mobile phone.

 *Some mobile phones require that the transfer is confirmed from the phone's keypad.*



Pairing Phones

Initial Pairing

Use this procedure when pairing the first mobile phone to the hands-free system. If the hands-free system is not ON or in use, press **PHONE**.

The **DISPLAY** will show NO PAIRED PHONES. PRESS ENTER AND SELECT ADD A PHONE. Press **EXIT** to cancel. Press **ENTER**.

The hands-free system will be asked if bluetooth is in discoverable mode (refer to the mobile phone manufacturer's instructions). If yes press **ENTER**. After a short while a list of phones which are in range and in discoverable mode will be shown.

 If the  symbol is shown in the **DISPLAY** when the ignition is ON, initial pairing can be completed using the mobile phone.

Press the **JOYSTICK** (up or down), **SCROLL** button or turn the **TUNING** dial to navigate to the required mobile phone and press **ENTER**. The **DISPLAY** will then ask for a passkey to be entered into the mobile phone. The mobile phone will prompt for the passkey. Enter the passkey into the mobile phone.

The **DISPLAY** will show PHONE CONNECTING... then, if successful, SYNCHRONISING.

Once synchronising has completed the mobile phone is ready for use.

 If the passkey is not entered after 20 seconds the screen will time-out.

 Synchronising automatically places all the mobile phone contacts onto the vehicle system.

Pairing Additional Phones

Pairing Using the Hands-Free System

 Disconnect any in use phones before pairing additional phones. If a phone is connected to the hands-free system pairing a new phone will not be possible until the hands-free system has no in use bluetooth connections.

 If, after 30 seconds, the hands-free phone has not been used, the infotainment system will default to audio functions. Return to hands-free phone functions by pressing **PHONE** or **CALL**.

Check that the mobile phone has bluetooth ON and visible. Check that the hands-free system is ON ( symbol will show in the **DISPLAY**).

The hands-free system automatically searches for the last used phone. If the last used phone is not found a list of paired phones will show along with <Add phone>. Select <Add phone> to pair a new phone to the system.

If the last used phone is found press **MENU** and navigate to <Phone Menu...> Enter <Bluetooth...> Enter <Change phone...> Enter <Add Phone...>.

Press **ENTER**. The hands-free system will be asked if bluetooth is in discoverable mode (refer to the mobile phone manufacturer's instructions). If yes press **ENTER**. After a short while a list of phones which are in range and in discoverable mode will show.

Press the **JOYSTICK** (up or down), **SCROLL** button or turn the **TUNING** dial to navigate to the required mobile phone and press **ENTER**.

The **DISPLAY** will then ask for a passkey to be entered into the mobile phone. The mobile phone will prompt for the passkey. Enter the passkey into the mobile phone.

The **DISPLAY** will show PHONE CONNECTING... then, if successful, SYNCHRONISING. Once synchronising has completed the mobile phone is ready for use.

 If the passkey is not entered after 20 seconds the screen will time-out.

 Synchronising automatically places all the mobile phone contacts onto the hands-free system.

Pairing Using the Mobile Phone

 Disconnect any in use phones before pairing additional phones. If a phone is connected to the hands-free system pairing a new phone will not be possible until the hands-free system has no in use bluetooth connections.

Check that the hands-free system is selected ( symbol will show in the **DISPLAY**).

Follow the mobile phone manufactures instructions to search and connect to a new bluetooth device. The phone will search for discoverable bluetooth devices in its range.

Select ASTON MARTIN from the device list. The phone will prompt for a passkey.

 If ASTON MARTIN does not show check that the hands-free system is selected and search again.

Press **MENU** (on the vehicle) and move to <Phone menu...> Enter <Bluetooth...> Enter <Connect from Mobile Phone> Enter. The **DISPLAY** will then show a passkey, enter the passkey into the mobile phone.

The **DISPLAY** will show PHONE CONNECTING... then, if successful, SYNCHRONISING. Once synchronising has completed the mobile phone is ready for use.

 If the passkey is not entered after 20 seconds the screen will time-out.

 Synchronising automatically places all the mobile phone contacts onto the vehicle system.

Removing a Paired Phone

Using the hands-free system

Press **MENU**. Navigate to <Phone menu...> Enter <Bluetooth...> Enter <Remove Phone> Enter.

A list of paired phones will show. Navigate to the required phone and press **ENTER** to erase or **BACK** to cancel.

Selecting a Phone

 The phone to be selected must have bluetooth ON, visible and in close proximity to the hands-free phone system.

A phone can be selected by using the phone itself or by using the hands-free system:

Using the Mobile Phone

If not ON or not selected, press **PHONE**.

Using the Mobile phone, follow the manufactures instructions to search and connect to a bluetooth device. The phone will search for discoverable bluetooth devices in its range. Select ASTON MARTIN from the device list. Select Connect.

 If ASTON MARTIN does not show check that the hands-free system is selected and search again. If ASTON MARTIN still does not show the mobile phone may not be paired (Refer to 'Pairing Phones', page 9.5)

Using the Vehicle hands-free system

With the hands-free system already selected, press **MENU** and navigate to <Phone Menu...> Enter <Bluetooth...> Enter <Change Phone> Enter. A list of paired phones will show (along with Add phone). Navigate to the required phone and press **ENTER** to change or **BACK** to cancel.

Or, if the hands-free system is not ON:

Press **PHONE**. The system will then scan for the last used mobile phone. If found and it is the mobile required then press **ENTER**. If the last phone is not found the **DISPLAY** will show a list of paired phones within range (with bluetooth ON). Navigate to a phone and press **ENTER** to select that phone.

Using a Phone

Making a Call

Check that the hands-free system is selected ( symbol shows in the **DISPLAY**).

Press **PHONE**, or **CALL** on the steering wheel controls.

- Press the **JOYSTICK** (up or down), **SCROLL** button, or turn the **TUNING** dial to select a contact from the phone book. Press **CALL** or **ENTER** to call.

Or

- Dial the number using the keypad and press **CALL** or **ENTER** to call. Press **BACK** to erase a number. Press and hold **BACK** to erase the whole number.

Ending Calls

To end a call press **CANCEL** or **BACK**.

Reject a Call

Press **CANCEL** or **BACK** while the phone is ringing.

Calling Using Voice Recognition

If the mobile phone supports voice dialling:

Press, hold and release **CALL** or **ENTER**. The amount of time required to hold in **CALL** or **ENTER** is dependant on the mobile phone.

Once 'Voice Tag Dialling' shows on the **DISPLAY**, allow one to two seconds before saying a name. The vehicle system will call the contact.

Receiving Calls

To answer an incoming call press **CALL** or **ENTER**.

Automatic Answer - ON or OFF

The automatic answer function means that calls are accepted automatically after four rings.

Press **MENU** and navigate to <Phone menu...> Enter <Phone settings...> Enter <Call options...> Enter <Automatic answer> Enter.

Phone Book

The mobile phone's phone book is synchronised automatically to the vehicle system at each connection.

If it is not required to synchronise to phone book:

Press **MENU** and navigate to <Phone menu...> Enter <Phone settings...> Enter <Synchronising phone book> Enter.

If the phone book contains a caller's contact information, this is shown in the **DISPLAY**.

 *If the mobile phone does not support copying of the phone book, 'List is empty' is shown when copying is finished.*

Contact Search

Searching for contacts is only performed in the connected mobile phone's phone book. Either:

Press the **JOYSTICK** (up or down), **SCROLL** button, or turn the **TUNING** dial to bring up the contact list. Navigate to the contact. Press **CALL** or **ENTER** to call.

Or

Use the **KEYPAD** to search the phone book. Press and hold a key (2 to 9) which relates to the first letter of the contact's name. This starts a search in the phone book based on the key's first letter. Navigate to the contact. Press **CALL** or **ENTER** to call.

Or

Press **PHONE**. Press **MENU** and navigate to <Phone menu...> Enter <Phone book...> Enter <Search> Enter. Using the **KEYPAD**, enter the first few letters of the contact name, press **ENTER**.

Navigate to a contact. Press **CALL** or **ENTER** to call.

Voice Mailbox

To enter a voice mailbox number:

Press **MENU** and navigate to <Phone menu...> Enter <Phone settings...> Enter <Call options...> Enter <Voice mail number> Enter <Enter the number> Enter

Or

Press and hold **KEYPAD** number 1 to go to <Voice mail number>. Enter the number and press **ENTER**.

Use the stored number by pressing 1 for several seconds.

To change the voice mail number go to *Voice mail number*. Press and hold **BACK** to erase the whole number or press and release to erase individual numbers. Once the number has been erased then enter a new number.

 *If the mobile phone has the voice mail number already stored then this will be placed into the system when synchronising during pairing.*

Last Ten Numbers

Last Ten Dialed Numbers

Press **ENTER**. Use the **JOYSTICK** (up or down), **SCROLL** button, or turn the **TUNING** dial to navigate to the required number. Press **CALL** or **ENTER** to call that number.

Last Ten Missed and Received Numbers

Press **MENU** and navigate to <Phone menu...> Enter <Last 10 missed calls> or <Last 10 received calls> Enter.

Use the **JOYSTICK** (up or down), **SCROLL** button, or turn the **TUNING** dial to navigate to the required number. Press **CALL** or **ENTER** to call that number.

 *Last ten dialed will also be available.*

Hands-Free Menu

1) Phone Menu...

- 1) Last 10 missed calls
- 2) Last 10 received calls
- 3) Last 10 dialed calls
- 4) Phone book...
 - 1) Search
 - 2) Copy fr. mobile phone
- 5) Bluetooth...
 - 1) Change Phone...
 - 2) Remove Phone
 - 3) Connect from mobile phone
- 6) Phone settings...
 - 1) Call options...
 - 1) Automatic answer
 - 2) Voice mail number
 - 2) Sounds and volume...
 - 1) Ring volume
 - 2) Ring signals...
 - 3) Mute Radio
 - 3) Synchronising phone book



ASTON MARTIN



ASTON MARTIN



ASTON MARTIN



ASTON MARTIN

Introduction

© 2010 Garmin Ltd. or its subsidiaries

All rights reserved. Except as expressly provided herein, no part of this chapter may be reproduced, copied, transmitted, disseminated, downloaded or stored in any storage medium, for any purpose without the express prior written consent of Garmin. Garmin hereby grants permission to download a single copy of this chapter onto a hard drive or other electronic storage medium to be viewed and to print one copy of this manual or of any revision hereto, provided that such electronic or printed copy of this chapter must contain the complete text of this copyright notice and provided further that any unauthorised commercial distribution of this chapter or any revision hereto is strictly prohibited.

Information in this chapter is subject to change without notice.

Garmin reserves the right to change or improve its products and to make changes in the content without obligation to notify any person or organisation of such changes or improvements. Go to the Garmin Web site (www.garmin.com) for current updates and supplemental information concerning the use and operation of this and other Garmin products.

Garmin® and the Garmin logo are trademarks of Garmin Ltd. or its subsidiaries, registered in the USA and other countries. nüMaps™ is a trademark of Garmin Ltd. or its subsidiaries. This trademark may not be used without the express permission of Garmin. microSD™ is a trademark of SD-3C, LLC. NAVTEQ is a trademark in the U.S. and other countries.

Important Safety and Product Information

⚠ Warning: Failure to avoid the following potentially hazardous situations could result in an accident or collision resulting in death or serious injury.

⚠ Always use your best judgement, and operate the vehicle in a safe manner. Do not become distracted by the navigation system while driving, and always be fully aware of all driving conditions. Minimise the amount of time spent viewing the screen while driving and use voice prompts when possible.

⚠ Do not input destinations, change settings, or access any functions requiring prolonged use of the navigation system controls while driving. Bring the vehicle to a halt in a safe and legal manner before attempting such operations.

⚠ When navigating, carefully compare information shown on the screen to all available navigation sources, including road signs, road closures, road conditions, traffic congestion, weather conditions, and other factors that may affect safety while driving. For safety, always resolve any discrepancies before continuing navigation, and defer to posted road signs and road conditions.

⚠ The navigation software is designed to provide route suggestions. It is not a replacement for driver attentiveness and good judgement. Do not follow route suggestions if they suggest an unsafe or illegal manoeuvre or would place the vehicle in an unsafe situation.

Map Data Information

Garmin uses a combination of governmental and private data sources. Virtually all data sources contain some inaccurate or incomplete data. In some countries, complete and accurate map information is either not available or is prohibitively expensive.

Navigation System Controls

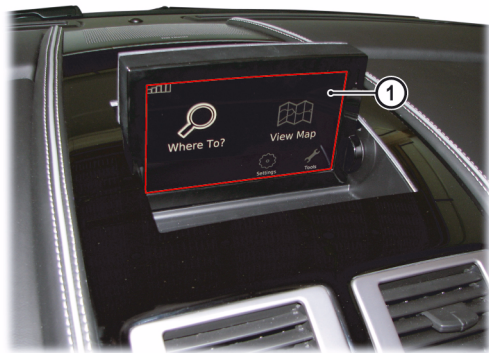

[1] SCREEN: Shows maps and provides detailed information on route type, distance, etc.

[2] BACK: Press to return to the previous menu or to undo a choice.

[3] NAV: Press to enable or disable Satellite navigation controls.

[4] JOYSTICK: Navigate through different menu options, traffic messages, etc.

[5] ENTER: Press to confirm, select or navigate from one submenu to the next submenu.

[6] MAP ZOOM: Press the rocker switch up or down to zoom the map in or out.



How to Set the Navigation System ON and OFF

 The screen shots shown in this manual may not exactly match the screens on your navigation system. The images used are intended for reference only.

1. Set the vehicle key to ignition position I or II.
2. Press **NAV** (LED ON). The navigation **SCREEN** will open and the disclaimer screen will show. Press **ENTER** to agree.

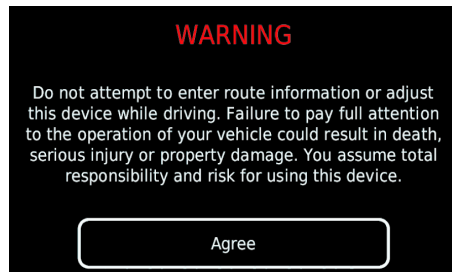

While the **NAV** button LED is ON the **BACK**, **ENTER** and **JOYSTICK** functions only operate the Navigation system. To use these functions for Audio or Hands-Free phone functions either:

- Press the **NAV** button again (button LED OFF). or
- Press any Audio button other than **BACK**, **ENTER** and **JOYSTICK**.

Press **NAV** (button LED ON) again to return to Navigation controls.

 Pressing the **AM/FM** or **MODE** buttons will move the current audio source.

 The navigation system can be accessed if the ignition is set to OFF. Always set the vehicle key to position 0 in the ignition control, and remove the vehicle key when the system is not in use to prevent the battery from discharging.

Navigation System OFF

At any time press and hold the **NAV** button until the system screen starts to close.

Menu Navigation

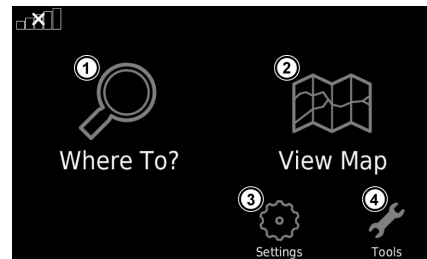

[1] : Find a destination (Refer to 'Find a Location', page 10.6)

[2] : View the map (Refer to 'Location Map', page 10.7).

[3] : System settings (Refer to 'System Settings', page 10.15).

[4] : System tools (Refer to 'Tools', page 10.14)

On-Screen Buttons

Select and hold  to quickly return to the navigation menu.

Select  or  to scroll the screen.

On-Screen Keyboard

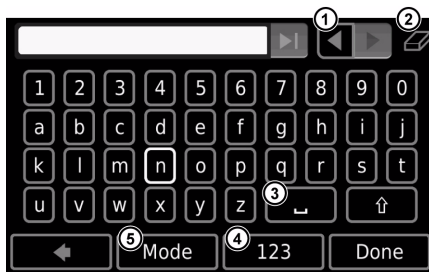

[1]  or : Move the cursor.

[2] : Delete a character.

[3] : Add a space.

[4] **123**: Enter numbers and special characters, such as punctuation marks.

[5] **MODE**: Select the keyboard language.

Find a Location

The Where To? menu provides several different categories you can use to search for locations.

Points of Interest

The detailed maps loaded in the navigation system contain millions of points of interest, such as restaurants, hotels, and transportation.

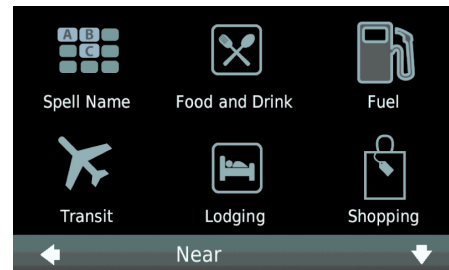

Point of Interest by Category

From the navigation menu, select *<Where To?> Enter <Points of Interest>*. Select a category.

If necessary, select a subcategory. Select an item.

Point of Interest by Spelling the Name

 *Narrow the search results by selecting a category prior to selecting Spell Name.*

From the navigation menu, select *<Where To?> Enter <Points of Interest> Enter <Spell Name>*.

Enter all or part of the name, and select *<Done>*.

Select an item.

Location Map

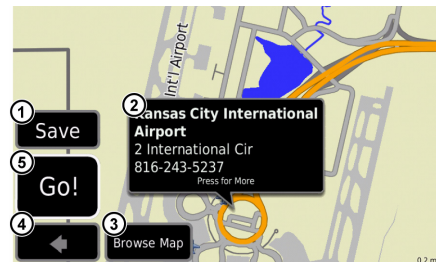

After a destination is selected, the location shows on the map.

[1] : Save this location to Favourites.

[2] : View more information for the location.

[3] : Explore the map.

[4] : Return to the previous screen.

[5] : Create a route to this location.

Map Zoom

To zoom in or out, select the up or down on the **MAP ZOOM** rocker switch mounted on the steering column.

Start a Route to a Location

Select a location. Select *<Go!>*.

Set a Home Location

Set your home location for the place you return to most often.

From the navigation menu, select *<Tools> Enter <My Data> Enter <Set Home Location>*.

Select *<Enter Your Address>*, *<Use Your Current Location>*, or *<Choose from Recently Found Locations>*.

Go Home

From the navigation menu, select *<Where To?> Enter <Go Home>*.

Edit Home Location

From the navigation menu, select <Where To?> Enter <Favourites> Enter <Home>.

Select <Press for More> Enter <Edit>. Select an option.

Find an Address

 Depending on the version of the maps loaded in your navigation system, the button names and the order of steps could be different from the steps below.

From the navigation menu, select <Where To?> Enter <Address>.

If necessary, change the state, country, or province.

To enter a city name or postal code, select <Spell City>, enter the name or code, and select <Done>.

To search all cities, select <Search All>.

 Not all map data provides postal code searching.

Enter the address number, and select <Done>.

Enter the street name, and select <Done>.

If necessary, select the street and or the address (Refer to 'Location Map', page 10.7).

Location by Browsing the Map

From the navigation menu, select <Where To?> Enter <Browse Map> (Refer to 'Location Map', page 10.7).

Review Recently Found Places

The navigation system stores the last 50 locations.

From the navigation menu, select <Where To?> Enter <Recently Found>.

Clear the List of Recently Found Locations

From the navigation menu, select <Where To?> Enter <Recently Found> Enter <Clear> Enter <Yes>.

All items in the list are removed, but this does not delete the actual location from your navigation system.

Find an Aston Martin Dealership

From the navigation menu, select <Where To?> Enter <Dealerships>. Select a dealer.

Enter Coordinates

If you know the geographic coordinates of your destination, you can use the navigation system to navigate to your destination using the latitude and longitude coordinates.

From the navigation menu, select <Where To?> Enter <Coordinates>.

Enter the coordinates, and select <Done>. Select <Next>.

Change the Map Coordinate Format

From the navigation menu, select <Where To?> Enter <Coordinates> Enter <Format>. Select a format.

Location Using a Phone number

From the navigation menu, select <Where To?> Enter <Phone Numbers>.

Enter a phone number, and select <Done>. If an exact match is found for the phone number, the location is shown.

 Searching by phone numbers is not available in all regions and on all maps.

Location in a Different area

From the navigation menu, select *<Where To?> Enter <Near>*.

Select *<Where I Am Now>*, *<A Different City>*, *<A Recent Destination>*, *<A Favourite Destination>*, *<My Current Route>*, or *<My Destination>*. Select *<OK>*.

Find a Different City

The navigation system lists all cities within a 20 mile radius of your current location.

From the navigation menu, select *<Where To> Enter <Cities>*.

Select an option:

- Select a city from the list of nearby cities that show
- Select *<Spell>* to enter the name of a city that does not appear on the list. Select an option.

 *The navigation system will navigate you to the centre of the selected city.*

Favourites

You can save places in your Favourites so you can quickly find them and navigate to them. Your home location is also stored in Favourites.

Save Current Location

From the main menu, select *<Tools> Enter <Where Am I?>*. Select *<Save Location>*.

Save Found Places

After searching for and finding a destination, you can save it as a Favourite. From the location map, select *<Save> Enter <OK>*.

Find Favourites

From the navigation menu, select *<Where To?> Enter <Favourites>*.

Edit Favourites

From the navigation menu, select *<Where To?> Enter <Favourites>*.

Select the location.

Select *<Edit>*.

Select an item to edit:

<Change Name>: Enter a new name.

<Change Map Symbol>: Select a new symbol used to mark this location on the map.

<Change Phone Number>: Enter a different phone number.

<Change Categories>: Select another category for the location.

Delete Favourites

From the main menu, select *<Tools> Enter <My Data> Enter <Delete Favourite(s)>*.

Select a Favourite. Select *<Delete> Enter <Yes>*.

Navigation Map

Map Features

! *The speed limit icon feature is for information only and does not replace the driver's responsibility to abide by all posted speed limit signs and to use safe driving judgment at all times.*

Garmin will not be responsible for any traffic fines or citations that you may receive for failing to follow all applicable traffic laws and signs.

The route is marked with a magenta line. A checkered flag marks the destination. As you travel, the navigation system guides you to the destination with voice prompts, arrows on the map, and directions at the top of the map. If you depart from the original route, the system recalculates the route and provides new directions. A current speed icon may show as you travel on major roadways.

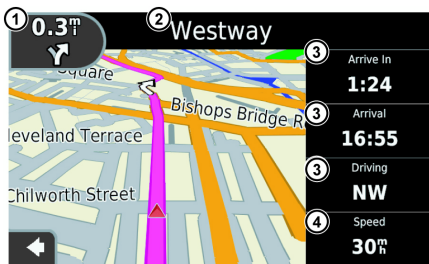

[1] : Show the next turn, or upcoming junction, when available (Refer to 'Viewing the Turn List', page 10.11).

[2] : Show the turn list.

[3] : Change the data display.

[4] : Show information about the trip.

Viewing Trip Information

The navigation system shows the current speed and provides statistics about your trip.

To view trip information from the map, select the Speed field. If you make frequent stops, leave the navigation system ON so it can accurately measure elapsed time during the trip.

Resetting Trip Information

From the trip information page, select <Reset>.

Select an option:

<Reset Trip Data>: Reset the trip information.

<Reset Max. Speed>: Reset the maximum speed.

Select <OK>.

Viewing the Turn List

When navigating a route, you can view all of the turns for the whole route and the distance between turns.

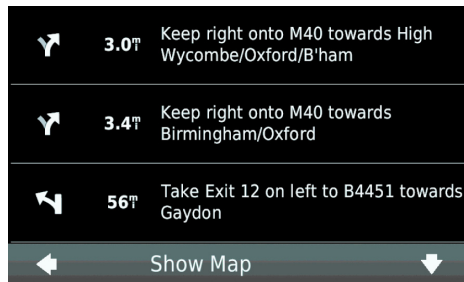

From the map, select the text bar on the top of the map. Select an option:

- Select a turn on the list to view information about the turn
- To view the entire route on the map, select <Show Map>

Viewing the next Turn

Before you can view the next turn in a route, you must be navigating a route.

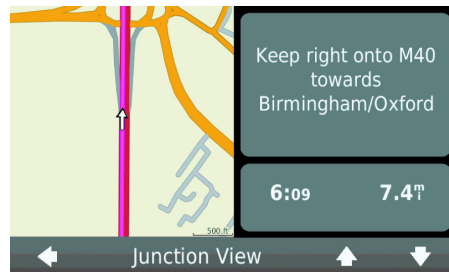

From the map, select the next turn icon. The next turn screen is shown on the map, along with the distance and time left before you reach the turn.

Junction View

When available, the navigation system may show a view of the upcoming junction and in which lane you should be driving will show. This feature is not available for all junctions.

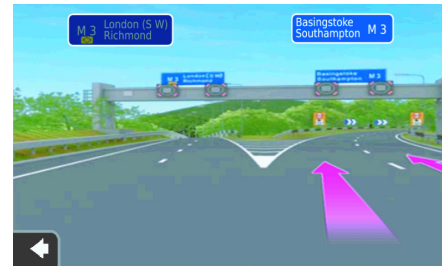

Before you can view the junction, you must be navigating a route. From the map, select the next turn icon. You can also view junctions from the turn list.

Make Changes to the Current Route

Add stops, remove points, or change your destination while on route.

Add One Point to Current Route

From the navigation menu select *<Where To?>*. Search for and select the extra stop.

Select *<Go!>*. Select *<Add as a Via Point>* to add this stop before your destination.

Add or Remove Multiple Points to the Current Route

From the navigation menu, select *<Tools> Enter <Routes>*.

Select *<Active Route> Enter <Add or Remove Points>*.

Select the point or points to add or remove:

<+>: Add a point.

<->: Remove a point.

Select *<Yes>*.

Changing the Destination of a Route

While navigating a route, select  to return to the navigation menu.

Select *<Where To?>*. Search for the location.

Select *<Go!>*. Select *<Start New Route>*.

Detour

When navigating a route, you can use detours to avoid obstacles ahead of you, such as construction zones.

While navigating a route, select  to return to the navigation menu. Select *<Detour>*.

If the current route is the only reasonable option, the navigation system might not calculate a detour.

Stopping the Route

While navigating a route, select  to return to the navigation menu. Select *<Stop>*.

Traffic

Garmin is not responsible for the accuracy or timeliness of the traffic information.

Your navigation system can receive FM Traffic Message Channel (TMC) traffic content, which provides information on nearby traffic incidents and construction. The subscription is automatically enabled and does not require an additional subscription purchase. Traffic information is not available in all areas.

Traffic Information

When you are within a traffic coverage area, your device will show traffic information. The navigation system must be in data range of an FM station transmitting traffic information.

Traffic Icon

When traffic information is being received, a traffic icon appears on the map. The traffic icon changes colour to show the severity of traffic conditions.

Colour	Severity	Meaning
Green	Low	Traffic is flowing freely
Yellow	Medium	Traffic is moving but there is a delay. There is moderate traffic congestion
Red	High	Traffic is not moving or moving very slowly. There is a severe delay

Traffic on Route

When calculating a route, the navigation system examines the current traffic and automatically optimises the route for the shortest time. If a severe traffic delay occurs on route while you are navigating, the device automatically recalculates the route.

You might still be routed through traffic if no better alternative routes exist.

Manually Avoiding Traffic on Your Route

From the map, select .

Select <Traffic On Route>. If necessary, use the arrows to view other traffic delays on your route. Select <Avoid>.

View the Traffic Map

The traffic map shows colour-coded traffic flow and delays on nearby roads.

From the map, select .

Select <Traffic Map> to view the traffic incidents on a map.

Search for Traffic Delays

From the map, select .

Select <Traffic Search> to view a list of roads with traffic delays.

Select an item in the list to view delays on the road. If there is more than one delay, use the arrows to view additional delays.

Tools

The Tools menu provides many features that are helpful when you are travelling.

View Current Location Information

Use the Where Am I? page to view information about your current location. This feature is helpful if you need to tell emergency personnel your location.

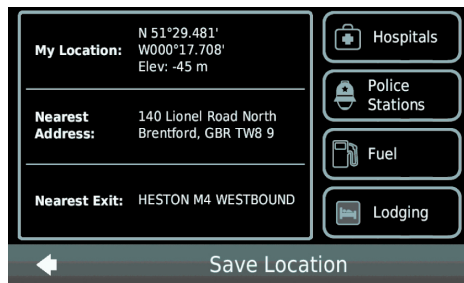

From the navigation menu, select *<Tools> Enter <Where Am I?>*.

Find Nearby Services

From the navigation menu, select *<Tools> Enter <Where Am I?>*. Select *<Hospitals>*, *<Police Stations>*, *<Lodging>*, or *<Fuel>* to view the nearest locations in that category.

Use Help

From the navigation menu, select *<Tools> Enter <Help to get information about using your navigation system>*.

Search Help Topics

From the navigation menu, select *<Tools> Enter <Help> Enter <Search>*.

Clear the Trip Log

From the navigation menu, select *<Tools> Enter <My Data>*. Select *<Clear Trip Log>*.

Routes

Up to 10 routes can be saved.

Create and Save a Route

From the navigation menu, select *<Tools> Enter <Routes> Enter <New>*.

Find a location (Refer to 'Find a Location', page 10.6) as your starting point, and select *<Select>*. Find a location for your ending point, and select *<Select>*.

If necessary, find and select additional locations to add them as stops along the route. The navigation system calculates and saves the route.

Navigate a Saved Route

From the navigation menu, select *<Tools> Enter <Routes>*.

Select a saved route. Select *<Go!>*.

Refer to Location Map (Refer to 'Location Map', page 10.7) for more information.

Edit a Saved Route

From the navigation menu, select *<Tools> Enter <Routes>*.

Select a saved route. Select *<Edit>*.

Select an item to edit:

<Change Name>: Enter a new name.

<Add or Remove Points>: Add or remove points from the route, change the order of points along the route, and automatically order the points.

<Manually Reorder Points>: Change the route order of the points.

<Optimally Reorder Points>: To edit the route using the map.

<Recalculate>: Recalculate the route.

<Delete>: Remove this route.

Changes are automatically saved when you exit any of the route edit pages.

Delete a Route

Select *<Tools> Enter <My Data> Enter <Delete Selected Route(s)>*.

Select a route(s) to delete. Select *<Delete>*.

World Clock

From the navigation menu, select *<Tools> Enter <World Clock>*.

Select a city name. Enter a new city name. Select *<Done>*.

If necessary, select a city option.

Calculator

From the navigation menu, select *<Tools> Enter <Calculator>*.

Customising the Navigation System

1. From the navigation menu, select *<Settings>*.
2. Select the setting you want to change.

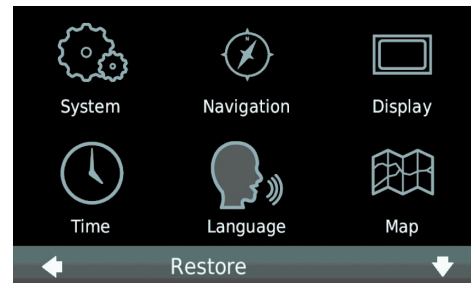

System Settings

From the navigation menu, select *<Settings> Enter <System>*.

GPS Simulator: Sets on the simulator to set the GPS mode to OFF and simulate navigation.

Units: Change the units of measure for distance.

Keyboard Layout: Selects QWERTY for a layout similar to a computer keyboard, or selects ABCDE for an alphabetical layout.

About: Shows the navigation system software version number, the unit ID number, and information on other software features.

Restore: Restores the system settings to factory default.

Navigation Settings

From the navigation menu, select *<Settings> Enter <Navigation>*.

Route Preference: Change the preference for calculating a route.

Avoidances: Change the road types to avoid.

Voice Prompts: Receive voice prompt directions.

Restore: Restores the original navigation settings.

Map Settings

From the navigation menu, select *<Settings> Enter <Map>*.

Map Detail: Adjust the amount of detail shown on the map. More detail can result in a slower map redraw rate in some areas or at wider zoom levels.

Map View: Change the map perspective.

- **Track Up:** Shows the map in two dimensions (2-D) with the direction of travel at the top.
- **North Up:** Shows the map in 2-D with north at the top.
- **3-D:** Shows the map in three dimensions (3-D) with the direction of travel at the top.

Vehicle: Change the icon used to show your position on the map

Trip Log: Show or hide the log of your travels.

Map Data Layout: Change the amount of data visible on the map.

Info: Shows the maps and the version of each map loaded on the navigation system. Select a map to enable (check mark) or disable (no check mark) that map.

Restore: Restore the original map settings.

Changing the Vehicle Icon

Select *<Settings> Enter <Map> Enter <Vehicle> Enter <Change>*.

Select the icon you want to use, and select *<Done>*.

Clearing the Trip Log

From the navigation menu, select *<Tools> Enter <My Data> Enter <Clear Trip Log>*.

Display Settings

From the navigation menu, select *<Settings> Enter <Display>*.

Colour Mode: Set a light background (Day), a dark background (Night), or automatically switches between the two based on the sunrise time and the sunset time for your current location (Auto).

Language Settings

From the navigation menu, select *<Settings> Enter <Language>*.

Voice: Set the language for voice prompts.

Text: Set all on-screen text to the selected language.

Keyboard: Set the language for the keyboard.

Restore: Restore the original language settings.

Proximity Points alerts Settings

From the navigation menu, select *<Settings> Enter <Proximity Points> Enter <Change> Enter <Audio>*.

Proximity Alerts: Set the alerts ON or OFF when you approach safety cameras.

Restore: Restore the original proximity points settings.

Security Settings

From the navigation menu, select <Settings> Enter <Security>.

Safe Mode: Set Safe Mode ON or OFF.

Restore: Restore the original security settings

Information

When the navigation system has acquired satellite signals, the signal

strength bars on the navigation menu are white . The more white bars, the stronger the GPS signal. If the navigation system

is not receiving GPS signals, the bars will show red .

For more information about GPS, go to www.garmin.com/aboutGPS.

View Detailed GPS Signal Information

From the navigation menu, select <Tools> Enter <Satellite Status>.

Safety Cameras

! Garmin is not responsible for the accuracy of, or the consequences of using, a custom POI or safety camera database.

Safety camera information is available in some areas. For these areas, the navigation system includes the locations of hundreds of safety cameras. Your navigation system alerts you when you are approaching a safety camera and can warn you if you are driving too fast.

Contact Information

Contact your Aston Martin dealership if you have questions while using your navigation system (Refer to 'Find an Aston Martin Dealership', page 10.8).

Software License Agreement

BY USING THE Aston Martin Lagonda navigation system, YOU AGREE TO BE BOUND BY THE TERMS AND CONDITIONS OF THE FOLLOWING SOFTWARE LICENSE AGREEMENT. PLEASE READ THIS AGREEMENT CAREFULLY.

Garmin grants you a limited license to use the software embedded in this device (the 'Software') in binary executable form in the normal operation of the product. Title, ownership rights, and intellectual property rights in and to the Software remain in Garmin. You acknowledge that the Software is the property of Garmin and is protected under the United States of America copyright laws and international copyright treaties. You further acknowledge that the structure, organization, and code of the Software are valuable trade secrets of Garmin and that the Software in source code form remains a valuable trade secret of Garmin. You agree not to decompile, disassemble, modify, reverse assemble, reverse engineer, or reduce to human readable form the Software or any part thereof or create any derivative works based on the Software. You agree not to export or re-export the Software to any country in violation of the export control laws of the United States of America.

NAVTEQ® End User License Agreement

The software embedded in your Garmin product (the 'Software') is owned by Garmin Ltd. or its subsidiaries ('Garmin'). The third-party map data embedded in or accompanying your Garmin product (the 'Map Data') is owned by NAVTEQ North America LLC and/or its affiliates and is licensed to Garmin. Garmin also licenses information, text, images, graphics, photographs, audio, video, images and other applications and data from third party data providers ('Third Party Content Data'). The Map Data and Third Party Content Data are collectively the 'Data'. Both the Software and Data are protected under copyright laws and international copyright treaties. The Software and Data are licensed, not sold. The Software and Data are provided under the following license and are subject to the following terms and conditions which are agreed to by End User ('you' or 'your'), on the one hand, and Garmin and its licensors (including their licensors and suppliers) and affiliated companies on the other hand.

IMPORTANT: CAREFULLY READ THIS LICENSE BEFORE USING THIS PRODUCT. INSTALLING, COPYING, OR OTHERWISE USING THIS PRODUCT INDICATES YOUR ACKNOWLEDGMENT THAT YOU HAVE READ THIS LICENSE AND AGREE TO ITS TERMS. IF YOU DO NOT AGREE, RETURN THE COMPLETE PRODUCT WITHIN 7 DAYS OF THE DATE YOU ACQUIRED IT (IF PURCHASED NEW) FOR A FULL REFUND TO THE DEALER FROM WHICH YOU PURCHASED THIS PRODUCT.

License Terms and Conditions

Garmin ('we' or 'us') provides you with storage media containing the computer Software (the 'Software') and the embedded or accompanying Data, including any 'online' or electronic documentation and printed materials (together called the 'Product' for purposes of this License Agreement), and grants you a limited, non-exclusive license to use the Product in accordance with the terms of this Agreement. You agree to use this Data together with the Garmin product for solely personal, or if applicable, for use in your business' internal operations, and not for service bureau, time-sharing, resale or other similar purposes. Accordingly, but subject to the restrictions set forth in the following paragraphs, you may copy this Data only as necessary for your use to (i) view it, and (ii) save it, provided that you do not remove any copyright notices that appear and do not modify the Software or Data in any way. You agree not to otherwise reproduce, copy, modify, decompile, disassemble, reverse engineer or create derivative works of any portion of the Product, and may not transfer or distribute it in any form, for any purpose, except to the extent permitted by mandatory laws. Garmin also reserves the right to discontinue offering any Data supplied by any third party supplier if such supplier ceases to supply such content or Garmin's contract with such supplier terminates for any reason.

Restrictions.

Except where you have been specifically licensed to do so by Garmin, and without limiting the preceding paragraph, you may not use this Data with any products, systems, or applications installed or otherwise connected to or in communication with vehicles, and which are capable of dispatch, fleet management or similar applications where the Data is used by a central control centre in dispatching a fleet of vehicles. In addition, you are prohibited from renting or leasing the Data or the Garmin products containing the Data to any other person or third party. Only those rental car companies that are specifically authorised by Garmin in writing to rent Garmin products containing the Data to their rental customers are permitted to rent out such products.

No Warranty.

This Product (including the Data) is provided to you 'as is,' and you agree to use it at your own risk. Garmin and its licensors (and their licensors and suppliers) make no guarantees, representations or warranties of any kind, express or implied, arising by law or otherwise, including but not limited to, content, quality, accuracy, completeness, effectiveness, reliability, merchantability, fitness for a particular purpose, usefulness, use or results to be obtained from the Product, or that the Data or server will be uninterrupted or error-free.

Disclaimer of Warranty.

GARMIN AND ITS LICENSORS (INCLUDING THEIR LICENSORS AND SUPPLIERS) DISCLAIM ANY WARRANTIES, EXPRESS OR IMPLIED, OF QUALITY, PERFORMANCE, MERCHANTABILITY, FITNESS FOR A PARTICULAR PURPOSE OR NONINFRINGEMENT. NO ORAL OR WRITTEN ADVICE OR INFORMATION PROVIDED BY GARMIN OR ITS SUPPLIERS AND LICENSORS SHALL CREATE A WARRANTY, AND YOU ARE NOT ENTITLED TO RELY ON ANY SUCH ADVICE OR INFORMATION. THIS DISCLAIMER OF WARRANTIES IS AN ESSENTIAL CONDITION OF THIS AGREEMENT. Some States, Territories and Countries do not allow certain warranty exclusions, so to that extent the above exclusion may not apply to you.

Disclaimer of Liability.

GARMIN AND ITS LICENSORS (INCLUDING THEIR LICENSORS AND SUPPLIERS) SHALL NOT BE LIABLE TO YOU: IN RESPECT OF ANY CLAIM, DEMAND OR ACTION, IRRESPECTIVE OF THE NATURE OF THE CAUSE OF THE CLAIM, DEMAND OR ACTION ALLEGING ANY LOSS, INJURY OR DAMAGES, DIRECT OR INDIRECT, WHICH MAY RESULT FROM THE USE OR POSSESSION OF THE INFORMATION; OR FOR ANY LOSS OF PROFIT, REVENUE, CONTRACTS OR SAVINGS, OR ANY OTHER DIRECT, INDIRECT, INCIDENTAL, SPECIAL OR CONSEQUENTIAL DAMAGES ARISING OUT OF YOUR USE OF OR INABILITY TO USE THIS INFORMATION, ANY DEFECT IN THE DATA OR INFORMATION, OR THE BREACH OF THESE TERMS OR CONDITIONS, WHETHER IN AN ACTION IN CONTRACT OR TORT OR BASED ON A WARRANTY, EVEN IF GARMIN OR ITS LICENSORS HAVE BEEN ADVISED OF THE POSSIBILITY OF SUCH DAMAGES.

GARMIN'S AND ITS LICENSORS' TOTAL AGGREGATE LIABILITY WITH RESPECT TO ITS OBLIGATIONS UNDER THIS AGREEMENT OR OTHERWISE WITH RESPECT TO THE GARMIN PRODUCT OR THE DATA SHALL NOT EXCEED \$1.00. Some States, Territories and Countries do not allow certain liability exclusions or damages limitations, so to that extent the above may not apply to you.

Disclaimer of Endorsement.

Reference to any products, services, processes, hypertext links to third parties or other Data by trade name, trademark, manufacturer, supplier or otherwise does not necessarily constitute or imply its endorsement, sponsorship or recommendation by Garmin or its licensors. Product and service information are the sole responsibility of each individual vendor. The NAVTEQ name and logo, the NAVTEQ and NAVTEQ ON BOARD trademarks and logos, and other trademarks and trade names owned by NAVTEQ North America LLC may not be used in any commercial manner without the prior written consent of NAVTEQ.

Export Control.

You agree not to export from anywhere any part of the Data provided to you or any direct product thereof except in compliance with, and with all licenses and approvals required under, applicable export laws, rules and regulations.

Indemnity.

You agree to indemnify, defend and hold Garmin and its licensors (including their respective licensors, suppliers, assignees, subsidiaries, affiliated companies, and the respective officers, directors, employees, shareholders, agents and representatives of each of them) free and harmless from and against any liability, loss, injury (including injuries resulting in death), demand, action, cost, expense, or claim of any kind or character, including but not limited to attorney's fees, arising out of or in connection with any use or possession by you of the Product (including the Data).

Canadian Map Data.

The Map Data for Canada may include or reflect data of licensors, including Her Majesty and Canada Post. Such data is licensed on an 'as is' basis. The licensors, including Her Majesty and Canada Post, make no guarantees, representations or warranties respecting such data, either express or implied, arising by law or otherwise, including but not limited to, effectiveness, completeness, accuracy or fitness for a particular purpose. The licensors, including Her Majesty and Canada Post, shall not be liable in respect of any claim, demand or action, irrespective of the nature of the cause of the claim, demand or action alleging any loss, injury or damages, direct or indirect, which may result from the use or possession of the data or the Map Data. The licensors, including Her Majesty and Canada Post, shall not be liable in any way for loss of revenues or contracts, or any other consequential loss of any kind resulting from any defect in the data or the Map Data.

You shall indemnify and save harmless the licensors, including Her Majesty the Queen, the Minister of Natural Resources of Canada and Canada Post, and their officers, employees and agents from and against any claim, demand or action, irrespective of the nature of the cause of the claim, demand or action, alleging loss, costs, expenses, damages or injuries (including injuries resulting in death) arising out of the use or possession of the data or the Map Data.

Term.

This Agreement is effective until such time as (i) if applicable, your subscription term is either terminated (by you or by Garmin) or expires, or (ii) Garmin terminates this Agreement for any reason, including, but not limited to, if Garmin finds that you have violated any of the terms of this Agreement. In addition, this Agreement shall terminate immediately upon the termination of an agreement between Garmin and any third party from whom Garmin licenses the Data.

Entire Agreement.

These terms and conditions constitute the entire agreement between Garmin (and its licensors, including their licensors and suppliers) and you pertaining to the subject matter hereof, and supersedes in their entirety any and all written or oral agreements previously existing between us with respect to such subject matter.

Governing Law

(a) For European Union NAVTEQ Data

The above terms and conditions shall be governed by the laws of the Netherlands, without giving effect to (i) its conflict of laws provisions, or (ii) the United Nations Convention for Contracts for the International Sale of Goods, which is explicitly excluded. You agree to submit to the jurisdiction of the Netherlands for any and all disputes, claims and actions arising from or in connection with the NAVTEQ Data provided to you hereunder.

(b) For North American NAVTEQ Data and other non-European Union NAVTEQ Data

The above terms and conditions shall be governed by the laws of Illinois, without giving effect to (i) its conflict of laws provisions, or (ii) the United Nations Convention for Contracts for the International Sale of Goods, which is explicitly excluded. You agree to submit to the jurisdiction of Illinois for any and all disputes, claims and actions arising from or in connection with the NAVTEQ Data provided to you hereunder.

(c) For disputes, claims and actions not related to the NAVTEQ Data

The above terms and conditions shall be governed by the laws of Kansas, without giving effect to (i) its conflict of laws provisions, or (ii) the United Nations Convention for Contracts for the International Sale of Goods, which is explicitly excluded. You agree to submit to the jurisdiction of Kansas for any and all disputes, claims and actions arising from or in connection with the Data provided to you hereunder.

Government End Users.

If End User is an agency, department, or other entity of the United States Government, or funded in whole or in part by the U.S. Government, then use, duplication, reproduction, release, modification, disclosure or transfer of the Product and accompanying documentation is subject to restrictions as set forth in DFARS 252.227-7014(a)(1) (JUN 1995) (DOD commercial computer software definition), DFARS 27.7202-1 (DOD policy on commercial computer software), FAR 52.227-19 (JUN 1987) (commercial computer software clause for civilian agencies), DFARS 252.227-7015 (NOV 1995) (DOD technical data – commercial items clause); FAR 52.227-14 Alternates I, II, and III (JUN 1987) (civilian agency technical data and noncommercial computer software clause); and/or FAR 12.211 and FAR 12.212 (commercial item acquisitions), as applicable. In case of conflict between any of the FAR and DFARS provisions listed herein and this License, the construction that provides greater limitations on the Government's rights shall control.



ASTON MARTIN



ASTON MARTIN



ASTON MARTIN



ASTON MARTIN



ASTON MARTIN

Maintenance

Introduction	11.2	Brake Pad 'Bedding-in'	11.11	Headlamp	11.25
Vehicle Jacking	11.3	Tyres	11.12	Other External Lamps	11.26
Servicing Precautions	11.3	Winter Tyres	11.13	Boot Lamps	11.26
Dangerous Substances	11.4	Tyre Sealant Kit	11.14	Internal Lamps	11.27
Emergency Items	11.4	Vehicle Recovery	11.15	Tourist Headlamp Adjustment	11.27
Owner Maintenance	11.5	Vehicle Battery	11.17	Door Window Reset	11.28
Bonnet Release	11.6	Vehicle Battery Charge	11.19	Front Seat Reset	11.28
Fluid Levels	11.8	Battery Protection Mode	11.20	Bodywork Maintenance	11.29
Windscreen Blade Replacement	11.11	Fuse Boxes	11.22	Vehicle Cleaning	11.29
				Vehicle Storage	11.32

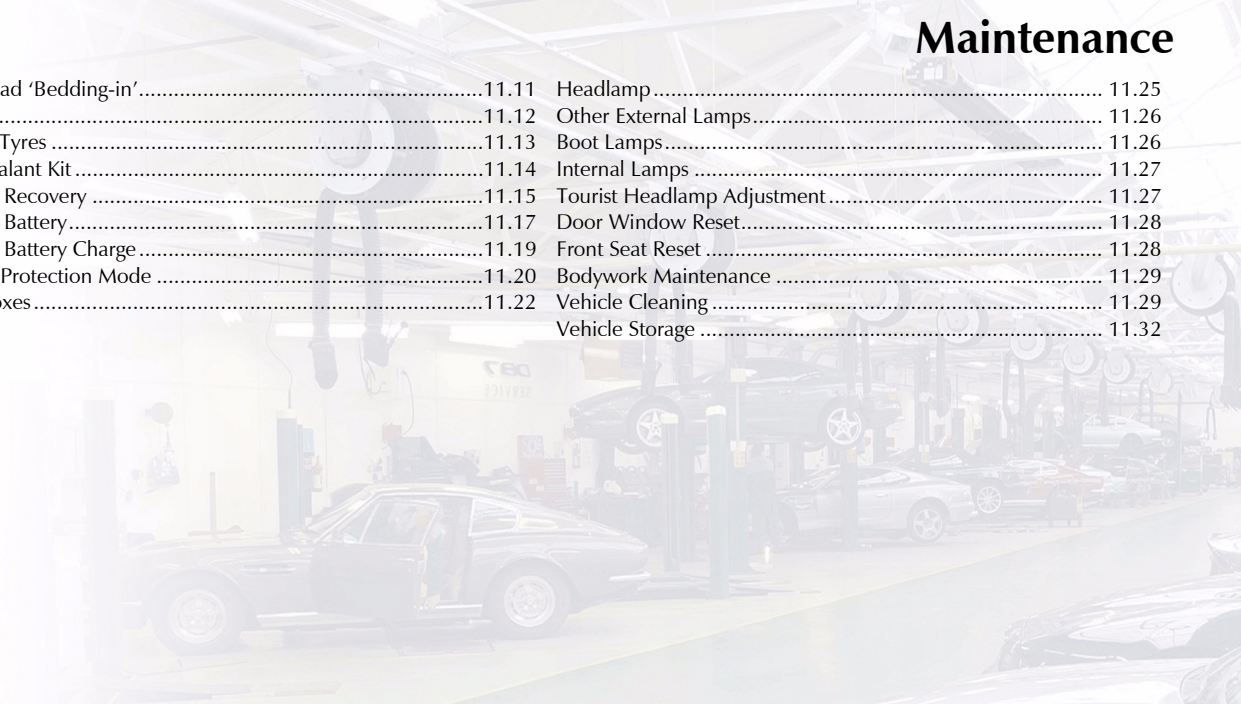

Introduction

Each item in the service schedules must be performed on time as failure to do so may void the new vehicle warranty or other warranties. It is the owner's responsibility to see that the vehicle is maintained correctly and in accordance with the manufacturer's service schedules.

Due to the sophistication of the various systems and the specialised equipment required to maintain this vehicle, owner maintenance should be restricted to the routine procedures described in this owner's guide.

If you think that this vehicle is not functioning correctly, please return it to an Aston Martin Dealer to be checked professionally.

Restraint Systems

Aston Martin recommend that the inflatable (airbags) restraint systems and seat belt components installed to this vehicle are replaced at 10 (ten) year intervals from the date of manufacture on the certification label.

Electronic Fuel Injection

⚠ Warning: If the fuel system is allowed to run dry irreparable damage to the fuel pumps may occur.

⚠ Warning: Any modifications or additions to the fuel system not specifically designed by Aston Martin are prohibited. If carried out, they may cause damage to the fuel system which in some circumstances could result in fire. All Service Action Campaigns must be undertaken by an Aston Martin Dealer.

The electronic fuel injection system requires special equipment and test facilities to set up and maintain so that the vehicle gives maximum performance coupled with economy, reliability and safe vehicle emissions. You are, therefore, strongly advised to entrust all service work to an Aston Martin Dealer.

Parts and Lubricants

When undertaking a servicing task only parts, materials, lubricants, etc. that are specifically recommended by Aston Martin should be used. Failure to do so can result in damage to your vehicle and may invalidate your new vehicle warranty or other warranties (Refer to 'Aston Martin Warranty', page B.1).

⚠ Your vehicle's warranty may be invalidated if damage is caused by the use of incorrect engine oil. Low quality or obsolete oils do NOT provide the protection required by modern, high performance engines. Failure to use engine oil that meets the required specification could cause excessive engine wear, a build up of sludge and deposits, and increased pollution. It could also lead to engine failure.

Vehicle Jacking

⚠ Warning: Make sure that no persons are in the vehicle before jacking commences.

⚠ Warning: Make sure that the vehicle is parked on firm and level ground to give a secure base for the jack.

⚠ Warning: Do not raise the vehicle by placing a vehicle jack under the suspension arms.

If this vehicle is to be raised using a vehicle jack make sure that the following jacking points are use.

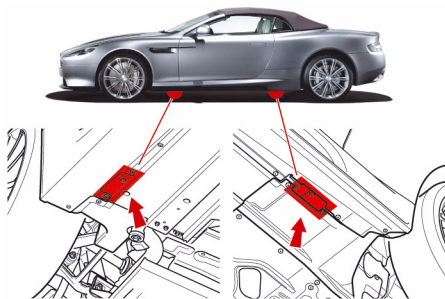

Servicing Precautions

To avoid personal injury, the following safety precautions must be observed when the bonnet is open and the engine is operating or the ignition is ON.

⚠ Warning: Protect yourself against dangerous substances (Refer to 'Dangerous Substances', page 11.4).

⚠ Warning: Keep hands, hair, tools, items of clothing and jewellery clear of all drive belts, pulleys and operating mechanisms. The cooling fans may operate even though the engine is not operating.

⚠ Warning: Avoid skin contact with all exhaust system and engine components, engine fluids and escaping steam. They may be hot and will burn you.

⚠ Warning: Do not breathe exhaust fumes. Exhaust fumes contain carbon monoxide. Carbon monoxide is a dangerous gas, which is colourless and odourless and can cause unconsciousness and may be fatal. Never start or leave the engine running in an enclosed, unventilated area.

⚠ Warning: Do not work beneath the vehicle with a vehicle lifting jack as the only support. Place suitable stands under the vehicle.

⚠ Warning: Keep children and pets clear of the vehicle. Do not let anyone inside the vehicle unless specifically working to your instructions.

⚠ Warning: Whenever possible work in the engine compartment with the engine cool, the ignition OFF and the vehicle battery disconnected.

⚠ Warning: Petrol is highly flammable and, in confined spaces, is also explosive and toxic. In the event of spillage, set the engine to OFF, use no naked flame or light. Do not smoke. Do not inhale fumes.

Dangerous Substances

⚠ Warning: *Dangerous substances should be kept out of reach of children.*

⚠ Warning: *Many liquids and other substances used in motor vehicles are poisonous and should under no circumstances be consumed and should, so far as possible, be kept from contact with the skin. These substances include battery electrolyte, antifreeze, oil, brake and clutch fluid, petrol, windscreen washer additives, lubricants, refrigerant and various adhesives.*

⚠ Warning: *Particular care should be taken to avoid unnecessary contact with used engine oil. Always read carefully the instructions printed on labels or stamped on components and follow them carefully. Such instructions are included for reasons of your health and personal safety. Never disregard them.*

Engine Oils

⚠ Warning: *Prolonged and repeated contact with used engine oils can cause serious skin disorders, including dermatitis and cancer. Avoid excessive contact, wash thoroughly after contact. Keep out of reach of children. When your oil is changed, be sure that it is done by an experienced person. In addition, observe all laws regarding the disposal of waste oil and toxic fluids.*

Protect The Environment

⚠ Warning: *It is illegal to pollute drains, water courses, or soil. Use authorised waste disposal facilities, including civic amenity sites and garages providing facilities for receipt of used oil. If in doubt, contact your local authority for advice.*

Emergency Items

The following emergency items are located in the boot.

[1] : Tyre Sealant Kit (Refer to 'Tyre Sealant Kit', page 11.14)

[2] : First Aid Kit¹

[3] : Warning Triangle.

⚠ Always follow local regulations when placing a warning triangle.

[4] : Towing eye (Not shown (located in the vehicle tool kit)).

[A] : Coupe

[B] : Volante

¹. Option.

Owner Maintenance



In the interests of safety and reliability, it is advisable to carry out the following checks at the intervals suggested (more frequently if your vehicle is heavily used or operating in adverse conditions), and always before starting on a long journey. Refer to the following pages for advice and check procedures.

Before Use Check:

- Operation of lamps, horn, indicators, wipers, washers and warning symbols
- Check there is sufficient fuel for the intended journey, particularly at night and before entering motorways
- Operation of the seat belts
- Operation of the brakes
- Check for fluid deposits underneath the vehicle

Weekly Checks

(daily if covering high mileage or touring)

- Tyres
- Coolant level
- Brake fluid level
- Power steering level
- Operate Air Conditioning
- Windscreen washer fluid level
- Check operation of windscreen washers

Fuel Filler Bowl

During fuel filling check that the fuel filler bowl drain pipe is free from debris which may block the pipe. If the pipe is blocked water can not drain from the bowl and can overflow into the fuel tank.

Engine Oil Level

! *It is important to check the engine oil level regularly. Running the engine with engine oil below the lower mark or above the upper mark can cause serious engine damage.*

Check the engine oil level every fourth fuel tank fill or weekly - whichever is the sooner.

Tool Kit

A vehicle tool kit is located underneath the trim panel in the left side of the boot floor.

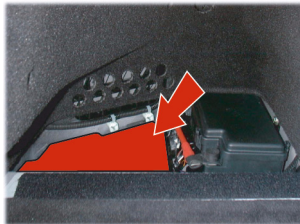

The tool kit consists of:

- Towing eye (Refer to 'Vehicle Recovery', page 11.15)
- Screwdriver
- Allen Key: For manual operation of the convertible roof¹.

Battery Conditioner

Option

A battery conditioner is located in boot storage area.
(Refer to 'Battery Conditioner', page 11.19)

Bonnet Release

⚠ Warning: Do not pull on the bonnet secondary catch to assist in closing the bonnet. This may displace the bonnet secondary catch. If the catch is displaced it may not work correctly.

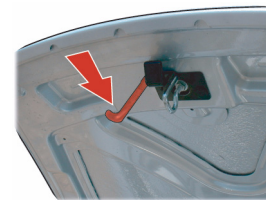

⚠ Do not press down hard on the bonnet if it has not closed correctly. This may damage the bonnet.

⚠ Take care not unintentionally to pull on or catch the bonnet release lever.

To open the bonnet pull the lever (A (left front footwell)) to release the bonnet latch. The bonnet will rise but stay secured by the bonnet secondary catch.

¹ Volante only.

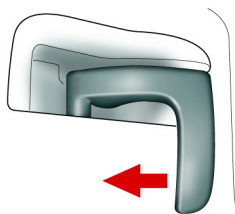

Lift slightly on the bonnet front edge whilst pulling upward on the bonnet secondary catch (B) to release it. Lift the bonnet until fully open. The bonnet is held open by two gas struts.

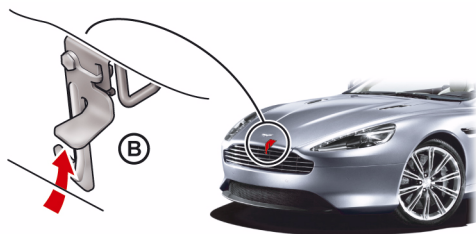

 *If the windscreen wipers are operating, they will temporarily rest in the park position while the bonnet is unlatched.*

 *Before closing the bonnet, remove any tools, cleaning cloths, etc. from the engine compartment. Make sure that no one is obstructing the 'closing' area and that hands, clothing etc. are clear.*

 *If the bonnet does not fully close or it opens during driving the message centre (right) will show BONNET OPEN.*

To close the bonnet lower the bonnet until it starts to fall under its own weight. At that point let the bonnet fall to close.

If the bonnet does not shut, open the bonnet again and repeat the closure procedure, this time assist using light hand pressure as the bonnet falls.

Fluid Levels

⚠ Warning: Engine components may be hot and could cause severe burns.

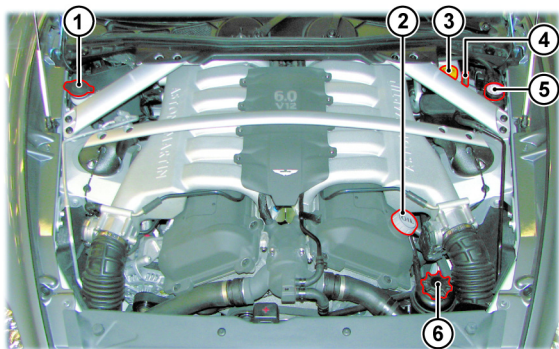

[1] : Washer fluid reservoir.

[2] : Engine oil filler cap.

[3] : Brake fluid reservoir¹.

[4] : Engine oil dipstick.

[5] : Engine coolant reservoir.

[6] : Power steering fluid reservoir.

Windscreen Wash Fluid Level

Top up as required. In winter, to prevent the windscreen wash fluid freezing, increase the fluid concentration (refer to the manufacturers recommendations on the windscreen wash fluid container).

When the level of windscreen wash fluid is low an information message will show in the message centre (right) and the amber warning symbol will come ON.



Local or state regulations may restrict the use of volatile organic compounds (VOCs), which are commonly used as antifreeze agents in windscreen washer fluid. A windscreen washer fluid with limited VOC content should be used only if it provides adequate freeze resistance for all regions and climates in which the vehicle will be operated.

Windscreen Washer Jets

The washer jet housings are located on the rear edge of the bonnet. Each housing contains two washer jets.

Windscreen washer jets are set during manufacture and should not need adjustment. However, if adjustment is required, adjust up or down so that the fluid strikes between a third and half way up the windscreen.

¹. Changes sides for left and right hand drive.

Brake Fluid Level

⚠ Warning: Do not drive the vehicle if the brake fluid level is below the minimum mark.

! Make sure that the brake fluid does not contact the paint work during the topping up operation. Serious paint work damage can result. If a spillage does occur, immediately flush any brake fluid from the paint work with clean, fresh water and then wipe with a clean damp cloth.

The brake fluid level should read between the Min. and Max. marks.

1. Remove the reservoir cap. Top up to the Max. level.
2. Install the reservoir cap securely.



Engine Coolant Level

⚠ Warning: Do not remove the filler cap until the coolant system has cooled. Scalding can be caused by escaping steam or coolant.

 Use a cloth or glove to protect hands and protect face and arms adequately.

1. Remove the pressure cap to check the coolant level. The correct coolant level is to the top of the reservoir tank. Top up with the correct antifreeze mix, if required (Refer to 'Fluids and Capacities', page 12.9).
2. Make sure that the filler cap is secure after topping up.

! Do not over tighten.

If required to remove the pressure cap before the engine is cold, **use gloves or a protective cloth** and slowly loosen the pressure cap. Allow residual pressure to slowly drop. Continue to turn the pressure cap until it is released.



Power Steering Fluid Level

! Make sure that the power steering fluid does not contact the paint work during topping up. Serious paint work damage can result. If a spillage does occur, immediately flush any power steering fluid from the paint work with clean fresh water, then wipe with a clean damp cloth.

Always check the reservoir level when the engine is cold and with the front road wheels in the straight ahead position.

Wipe the reservoir cap clean before removing to prevent an ingress of contaminants.

1. Remove the reservoir cap and wipe the dipstick clean with a lint free cloth. Replace and remove again. The fluid level should read between the Min. and Max. marks.
2. If required, top up fluid level. **Do not overfill.**



Engine Oil Level

⚠ Warning: Engine oil or components may be hot and could cause severe burns.

⚠ Running the engine with engine oil below the lower mark or above the upper mark can cause serious engine damage.

⚠ This vehicle's warranty may be invalidated if damage is caused by the use of incorrect engine oil. Low quality or obsolete oils do NOT give the protection required by modern, high performance engines.

⚠ Failure to use engine oil that meets the required specification could cause excessive engine wear, a build up of sludge and deposits, and increased pollution. It could also lead to engine failure (Refer to 'Fluids and Capacities', page 12.9).

- The vehicle should be on level ground
- Check the oil level when the engine completely cold
- Check the engine oil level every fourth fuel tank fill or weekly - which ever is the sooner

Oil level check:

1. Withdraw and wipe the dipstick clean, using a lint free cloth.
2. Fully insert the dipstick with the Min. and Max. marking on the blade upwards (facing towards the engine). Withdraw again.

 Approximately one litre (two pints) is required to bring the level from Min. to Max.



3. The oil level should read between the Min. & Max. marks.

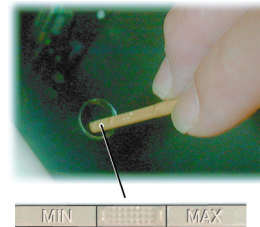

4. If required remove the filler, top up to the Max. mark with the recommended engine oil.
5. Wait for approximately two minutes for the oil to settle, then check the level again. Add oil if required. **Do not overfill.**



6. Replace the filler cap securely, replace the dipstick & press it home.

Windscreen Blade Replacement

To replace the windscreen wiper blades the wiper arms must be set at 90° to the vehicle (A). Press and hold in buttons 2 and 6 on the Infotainment keypad. Insert the vehicle key in the ignition control and move to position 'II' (ignition ON). This will manoeuvre the wiper blade arms to the 90° position. Return the vehicle key to position '0'.

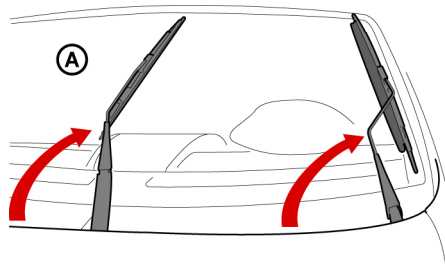

Lift the wiper arm(s) up, press at point B and remove the worn wiper blade(s). Install the new wiper blade(s) and lower the wiper arm(s).

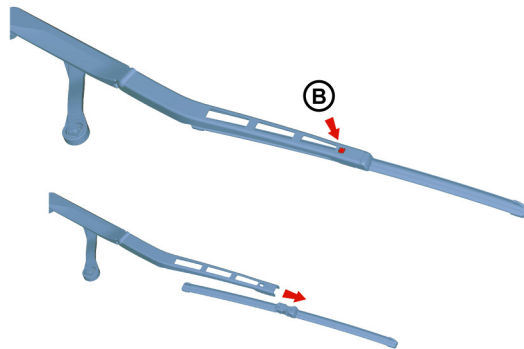

After replacing the wiper blade either:

- Move the vehicle key back through to position 'II' to lower the wiper arms. Return the vehicle key to position '0' or remove
- Operate the wiper stalk - the wiper arms will complete the request and then park

Brake Pad 'Bedding-in'

⚠ Warning: Track day use and high speed driving: For track use or high speed driving new brake pads must be subject to specific conditioning. Failure to correctly condition the pads may result in greatly reduced brake performance. Contact your Aston Martin Dealer.

⚠ Failure to 'bed-in' new brake pads will result in reduced brake performance and possible brake judder or squeal.

After the installation of new brake pads, brake performance will be reduced, as the brake discs and pads need to be 'Bedded-in'. For the first few hundred kilometres of new brake pad use, avoid excessive braking (hard stops from high speed, alpine descents, etc.).

Tyres of the correct type, manufacturer and dimensions, with correct cold inflation pressures are an integral part of every vehicle's design. Regular maintenance of tyres contributes not only to safety, but to the designed function of the vehicle.

Road holding, steering and braking are especially vulnerable to incorrectly pressurised, badly installed or worn tyres.

Tyres of the correct size and type, but of different make have widely varying characteristics.

Only install tyres approved by Aston Martin.

Tyre Pressures

Make sure that correct tyre pressures are carefully maintained. Road holding, steering, braking and tyre wear are especially vulnerable to incorrect tyre pressures.

Check tyre pressures regularly and before starting any journey. Re-inflate any tyre with a low pressure at the earliest opportunity.

Pressures increase slightly when the tyres are hot. For an accurate reading, pressures should be checked when the tyres are cold. After adjusting the tyre pressures, make sure that the valve caps are securely replaced to provide an additional air seal and to prevent the ingress of dirt.

Tyre Service

 *Because of the high performance potential of this vehicle, Aston Martin strongly recommend replacement of any damaged or worn tyre.*

The recommended tyres for this vehicle are asymmetrical and must be installed to the wheel with the tyre mark 'Outside' on the outside of the wheel rim.

They are also of different sizes on the front and rear axles, therefore complete wheels cannot be swapped between axles. Complete wheels can, however, be swapped from side to side on the same axle.

Damage

Tyres should be examined at regular intervals for wear and damage. Inspect the tyre treads and sidewalls for damage, i.e. bulges in the tread or the sidewalls, cracks in the tread groove and separation in the tread or the sidewalls. If damage is observed or suspected have the tyre inspected by a tyre professional.

Stones or other objects which have become lodged in the tyre treads should be carefully removed.

Flat Spots

It is a characteristic of high performance tyres that temporary 'flat spots' may develop if the vehicle is left standing in high or low ambient temperatures for any length of time.

These 'flat spots' will manifest themselves as minor vibrations when the vehicle is first driven from cold. As the tyres warm up to operating temperature, normal tyre shape should be restored and the vibrations cease. If vibrations persist, consult your Aston Martin Dealer.

Age

 *Local regulations on tyre life may apply.*

Tyres degrade over time, even when they are not being used. It is recommended that tyres generally be replaced after five years of normal service. Heat caused by hot climates or frequent high loading conditions can accelerate the aging process.

New Tyres

New tyres should not be installed to the front wheels in combination with worn rear tyres, as rear end stability will be affected. When new tyres are required consult your Aston Martin Dealer for advice if the rear tyres are also worn. Each wheel and tyre unit must be balanced dynamically and measured for Radial Force Variation (RFV)¹ to make sure of efficient steering, optimum tyre wear and maximum ride comfort. Because of the potentially high speeds, it is essential that wheel balancing is carried out when new tyres are installed.

Running-In New Tyres

When new tyres have been installed, speed should be limited, particularly during the first 80 km or so of driving. Fast cornering, hard braking, and harsh acceleration should also be avoided during this period.

¹. Contact your Aston Martin Dealer for more information.

Tread Wear Marks

Tread wear marks (A) are incorporated into the construction of all tyres. These marks are integral moulded ribs spaced at regular intervals around the circumference of the tyre and extend across the full width of the tread, in all primary grooves.

When a tyre has worn causing one or more of the marks to be flush with the outer face of the tread the tyre has reached its wear limit. It then becomes illegal in certain countries and must be replaced.



Winter Tyres

The tyres installed as original equipment are designed with a rubber compound, tread pattern and width specially suited for high speeds in normal road conditions, but they are less suitable during extremes of low temperatures, snow and ice. The use of winter tyres will considerably improve handling during these conditions.

Only use Aston Martin approved winter tyres.

⚠ Warning: Maximum speed with winter tyres is 270 km/h.

Winter tyres must be used in vehicle sets, that is, installed on all four wheels. Do not exceed the tyre speed rating when using winter tyres.

Contact your Aston Martin Dealer.

Snow Chains

⚠ Warning: The maximum speed when using snow chains is 48 km/h. Remove the snow chains immediately the roads are clear of snow

These are available from your Aston Martin Dealer for temporary use when driving in heavy snow conditions. Snow chains should only be installed to the rear (driven) wheels.

 Make sure that the installation instructions supplied with the snow chains are kept in a safe place.

Tyre Sealant Kit

⚠ Warning: Do not use the system to seal a tyre that was damaged while driving with insufficient air pressure (e.g. tyre cuts, cracks, bumps or similar damage). Do not use the system to seal tyres with side wall damage. Only punctures in the tread area of tyres may be sealed.

⚠ Warning: Do not stand directly beside the tyre while the compressor is pumping. Watch the side wall of the tyre. If there are any cracks, bumps or similar damage set the compressor to OFF. The journey should not be continued. Contact your nearest Aston Martin Dealer.

⚠ Warning: If a tyre pressure of 1.8 bar cannot be reached then the tyre can not be sealed. Do not attempt to re-inflate the tyre. Contact your Aston Martin Dealer.

⚠ Warning: If the pressure in the tyre after driving for 3 km is below 1.3 bar the tyre has not been effectively sealed. The journey should not be continued. Contact your nearest Aston Martin Dealer.

⚠ Warning: After a longer period of rest, the tyre pressure should be rechecked.

⚠ The tyre sealant kit only provides temporary mobility. Always refer to local laws and regulations on the use and repair of tyres that have been treated with any form of temporary mobility aid. Consult a tyre specialist for advice.

 Inform the tyre specialist that the tyre contains sealant.

Location

The tyre sealant kit is located in the boot storage area (A (Coupe) and B (Volante)).

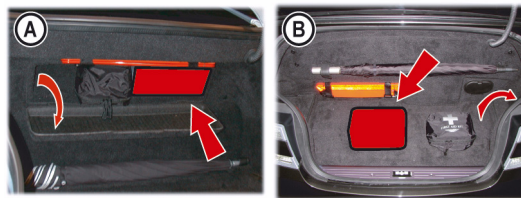

Operation

Read the following instructions and warnings carefully before using the tyre sealant kit. Compliance with these instructions is vital to make sure of vehicle and user safety. Noncompliance with these instructions means risking severe tyre damage and hazardous vehicle behaviour which can lead to a road accident involving damage to property or injury to persons.

- Make sure that the vehicle is parked far enough from traffic so that there is no danger from passing vehicles and so that you do not disrupt the traffic. Warn other vehicles using the warning triangle
- The system should only be used between temperatures of -40°C and 70°C
- A maximum speed of 80 km/h may not be exceeded at any time after sealing the tyre with the system
- The system provides only a **temporary emergency repair** for continuing the journey up to 200 km or to the nearest Aston Martin Dealer
- If the nearest Aston Martin Dealer is over a 200 km away arrange for collection under the Aston Martin Emergency Service scheme

- The system will effectively seal a tyre that was punctured by an object with a diameter of up to 6 mm. It is possible that a tyre, especially with greater damage, will not be sealed. Do not remove objects that punctured the tyre if they are still lodged in the tyre
- The sealant bottle needs to be exchanged before it expires. **Do not** use the system after the expiry date on the sealant bottle or casing has been reached. Contact your nearest Aston Martin Dealer
- Do not attempt to inflate other objects without using a system adapter and do not inflate objects with a volume greater than 50 litre (air mattresses, rubber boats, etc.). Do not let the system pump air for more than 10 minutes without stopping it and allowing it to cool down

Both the hose and the bottle of sealant need to be replaced after using the system. Sealant deposits in a used hose may cause the system to operate incorrectly. New bottles of sealant can be purchased from your Aston Martin Dealer.

Dispose of empty sealant bottles together with normal household waste.

Remains of liquid sealant must be handed over to your dealer or disposed of in compliance with local waste disposal regulations.

Vehicle Recovery

! When moving the vehicle by transporter make sure that the vehicle is not strapped down to the transporter by the suspension control arms.

! Power braking and power steering are not available with the engine OFF. Substantially higher brake pedal pressures and steering effort are required.

! If there is a transmission fault, this vehicle must be transported.

Your vehicle should always be recovered on a vehicle transporter¹ and should only be towed for **short distances**, for example, if it is causing an obstruction or if it requires winching onto a transporter. If moving the vehicle in such a situation:

¹. The recommended method for a recovering vehicle is to have it transported in a purpose built, covered, vehicle transporter.

1. Remove the towing eye from its storage location in the vehicle tool kit (located in the boot storage area), and install the towing eye to the exposed female threads (A)².

Install the towing eye in until it is against the vehicle body. Protect vehicle paint work when installing the towing eye.

2. When being towed use the footbrake very gently as required to prevent excessive slack in the tow rope.

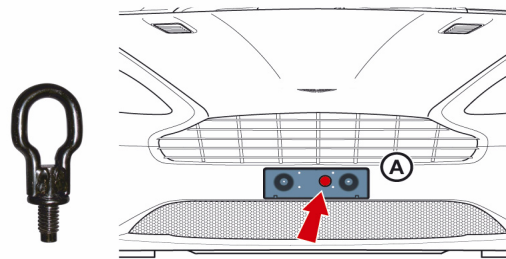

². The towing eye has a left hand thread.

Parklock Override

⚠ Apply the park brake before operating the park override lever. There is the danger that the vehicle will roll, depending on the incline of the road.

⚠ The warning message, GEARBOX FAULT, PARKLOCK FAILURE, in the message centre (right) must go OFF and the GPID must change from N to P. Otherwise there is the danger that the vehicle will roll away.

If the vehicle fails to start or has broken down the automatic transmission will move into P (park). To tow or move the vehicle use the parklock override lever to manually unlock the automatic transmission parklock.

Operating the Parklock Override

Apply the park brake. In the rear left passenger footwell (2+2 seating) or the rear left environment (2+0 seating) remove the left rear seat base or trim cover (A) and remove the two screws that secure the park override lever cover. Remove the cover.

Pull the parklock override lever (B) fully up on the ratchet, fully releasing the parklock.

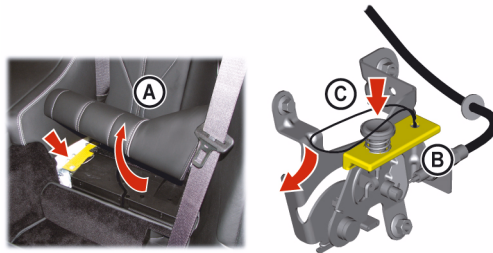

After towing or moving the vehicle apply the park brake.

Lift the parklock override lever slightly and press the ratchet release button (C). With the ratchet release button pressed lower the parklock override lever back to the stop. The parklock is now locked. Install the the park override lever cover and the rear seat base or trim panel.

Jump Start From Another Vehicle

⚠ Warning: The donor vehicle must have a 12 volt battery and a negative (-), black earth terminal to make sure that the correct battery polarity is maintained.

⚠ Apart from vehicle recovery, this vehicle must not be driven if the vehicle battery is incapable of starting the engine. In this case the vehicle battery must be replaced.

⚠ If the voltage or earth of the donor vehicle is different or not known, do not attempt starting in the way described.

If this vehicle will not start due to a discharged battery, it may be started, **for vehicle recovery**, by connecting the battery from another vehicle (donor) to this vehicle (recipient).

Jump Start Procedure

⚠ Remove rings, metal watch bands and any other jewellery.

⚠ Set all electrical motors and ancillaries in both vehicles to OFF.

⚠ Set all lamps to OFF except those needed to protect vehicles or illuminate the work area.

1. Position the donor vehicle so that the connecting cables will reach into the recipient engine bay. Apply the park brake and set the ignition to OFF.
2. Access the jump start terminal in the recipient engine bay.
3. Connect the positive (red) cable between the positive (red) terminal of the donor battery and the jump start terminal of the recipient vehicle (A).

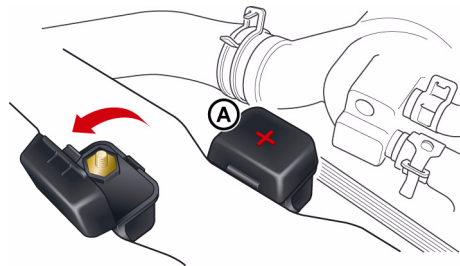

4. Connect the negative (black) cable between the negative (black) terminal of the donor battery and a good earth (negative) point in the recipient engine bay (i.e. alternator mounting bracket).

5. Start the donor vehicle engine and run at about 1500 – 2000 rpm.
6. Start the engine of the recipient vehicle.
7. Once both vehicles are running remove the jump start cables, first the negative (black) cable from both vehicles and then the positive (red) cable from both vehicles.
Allow the recipient engine to run until the discharged battery is sufficiently recharged (15 to 20 minutes) to start the engine without assistance. Set the engine to OFF and restart the engine. Take the vehicle on a long run to fully charge the battery. Contact your Aston Martin Dealer to have the battery checked or replaced.

 Recharge time will depend on the initial 'state of health' of discharged battery.

 If this vehicle will not start consult your Aston Martin Dealer.

Vehicle Battery

⚠ Warning: Battery posts, terminals and related accessories contain lead and lead compounds. Wash hands after handling.

⚠ Warning: Do not allow flames, sparks or lighted substances to come near the battery. Batteries normally produce explosive gases which can cause personal injury. When working near the battery, always shield your face and protect your eyes. Always have sufficient ventilation.

⚠ Warning: When lifting a plastic cased battery, excessive pressure on the end walls could cause acid to flow through the vent caps, resulting in personal injury, damage to the vehicle or battery. Lift the battery with a battery carrier or with your hands on opposite corners.

⚠ Warning: Keep batteries out of reach of children.

⚠ Warning: Batteries contain sulphuric acid. Avoid contact with skin, eyes or clothing. Shield your eyes when working near the battery to protect against possible splashing of acid solution. In case of acid contact with skin or eyes, flush immediately with water for a minimum of 15 minutes and get prompt medical attention. If acid is swallowed, get medical help immediately.

⚠ **The engine must never be run with the vehicle battery disconnected.**

⚠ **Apart from vehicle recovery, this vehicle must not be driven if the vehicle battery is incapable of starting the engine. In this case the vehicle battery must be replaced. Contact your Aston Martin Dealer.**

The vehicle battery is maintenance free and should only require checking by your Aston Martin Dealer during regular vehicle services. To access the vehicle battery remove the trim panel (A), located in the right rear environment.



Vehicle Battery Disposal

It is the responsibility of the vehicle owner when disposing of automotive batteries to do it in an environmentally correct manner.

The incorrect disposal of a vehicle (lead-acid) battery can be extremely hazardous to health and the environment. Most batteries contain heavy metals and when disposed of incorrectly, these heavy metals may leak into the ground. This can contribute to soil and water pollution and endanger wildlife.

Follow your local authorised standards for disposal. Call your local authorised recycling centre to find out more about recycling automotive batteries.

Do not dispose of your vehicle battery in the household waste.



Warnings

The following warnings are located on the vehicle battery.



Vehicle Battery Charge

Various systems, for example, the clock, security systems and Infotainment centre system continue to drain battery power even with the ignition OFF.

A **new fully charged** battery has the ability to start this vehicle, if left unused, for up to 45 days without a battery conditioner being used.

 *In cold climates this time may be reduced.*

 *Aston Martin recommend that if this vehicle is to be left unused for ten (10) days or more a battery conditioner (mains power available) should be used.*

Battery charge can be drained excessively in a number of ways:

- If the vehicle is unused for long periods of time
- If the vehicle is used regularly but only for short journeys, e.g. less than 48 km a journey
- If electrical systems are in use without the vehicle engine running
- If the vehicle key is left in the ignition control for long periods of time without the engine operating

Excessive battery drain would ultimately mean that the battery would not be able to start the engine.

Battery Conditioner

Option

 **Warning: Do not attempt to start the vehicle with a battery conditioner connected to the mains supply.**

 **Warning: Do not smoke. Prevent flames and sparks. Explosive gasses are given off by batteries during charging.**

 **A battery conditioner is designed for conditioning of partially or fully charged batteries. It will not effectively charge a discharged battery.**

 **For indoor use only. Disconnect mains supply before making or breaking battery connections.**

 *The battery conditioner supplied with the vehicle is suitable for use on all types of 12 volt lead acid batteries.*

If this vehicle is not going to be used for a period of time, and **mains power is available**, use a battery conditioner to maintain the battery charge level.

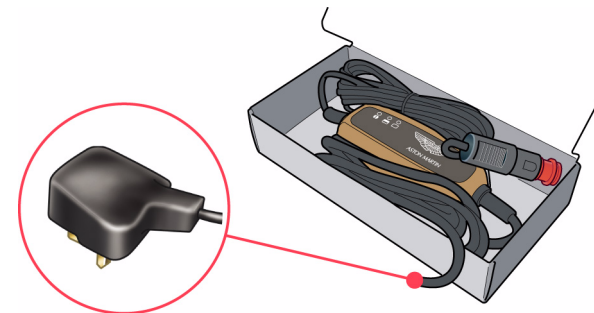

When connected the battery conditioner will maintain a small trickle charge to keep the battery in a fully charged state. The battery conditioner may be left in this state indefinitely.

To Connect a Battery Conditioner

1. Insert the accessory socket plug (B) into the accessory socket (A (located in the boot, rear wall, right side)).
2. Insert the mains plug (C) into the mains supply.
3. Gently close, but do not latch, the boot lid. This avoids possible damage to the boot lid water seal from the battery conditioner power cable.

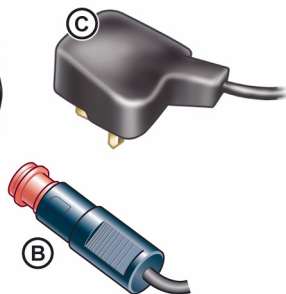
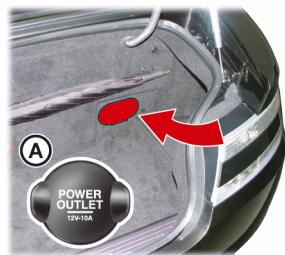
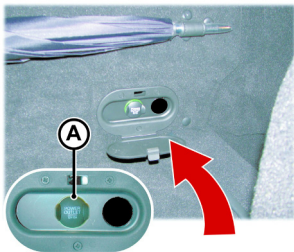

To remove the battery conditioner first disconnect from the mains supply, then from the vehicle socket.

 With the boot lid left open the vehicle doors can be locked and armed.

Battery Protection Mode

! *Replace the battery as soon as possible, if the battery is not capable of starting the engine.*

Using the vehicle electrical systems, i.e. the infotainment system, with the vehicle key at position 'I' (ignition OFF) will drain the battery charge. Eventually the battery will drain to such a low level that it will not start the engine.

To avoid this happening, a series of safety mechanisms shut down nonessential electrical systems before excessive battery drain takes place.

FAQ

What is the first sign of battery protection mode?

Two messages will show:

[A] : WARNING - LOW BATTERY (For 10 seconds).

[B] : LOW BATTERY



What should I do next?

Set all unnecessary electrical systems to OFF to reduce battery drain. Start the engine to recharge the battery. Run the engine for a reasonable length of time.

What happens if I ignore the warning messages?

After approximately two to ten minutes (dependent on the rate of battery charge drain) the following messages will show:

[A] : INFOTAINMENT WILL BE SHUT DOWN 2 MINUTES (For 10 seconds).

[B] : LOW BATTERY POWER SAVE.

If the audio system is ON the sound will mute for 10 seconds and a short 'Beep' will be heard when the message is first shown.

What should I do if these messages are shown?

Set all unnecessary electrical systems to OFF. Start the engine to recharge the battery. Run the engine for a reasonable length of time.

What happens if I ignore second warning messages?

The infotainment system will shut down in two minutes. No other electrical system will be shut down. This significantly reduces the rate of battery drain. The following functionality will be lost:

- CD Player
- Navigation System
- Radio Tuner

What should I do if the infotainment system shuts down?

Start the engine to recharge the battery. Run the engine for a reasonable length of time.

The infotainment system will not operate without the engine running until the battery has regained its charge. With the engine running the infotainment system will start up.

What is a reasonable length of time to run the engine?

The vehicle battery normally requires a journey of approximately 48 km to recharge. Additionally, use the battery conditioner to restore the vehicle battery charge.

What if I cannot restart the engine?

If the battery has been run down to a point where it will not start the engine then an external battery charger¹ will be required or your vehicle will require a 'jump start' (Refer to 'Jump Start From Another Vehicle', page 11.16).

¹ A battery conditioner is designed for conditioning of partially or fully charged batteries. It will not effectively charge a discharged battery.

Fuse Boxes

The electrical system is protected by fuses. If any lamps, accessories, or controls don't work, inspect the appropriate circuit protector.

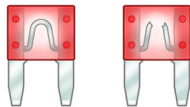

If a fuse has blown, the inside element will be melted. If the same fuse blows again, avoid using that system and consult your Aston Martin Dealer as soon as possible.

Fuse Box Location

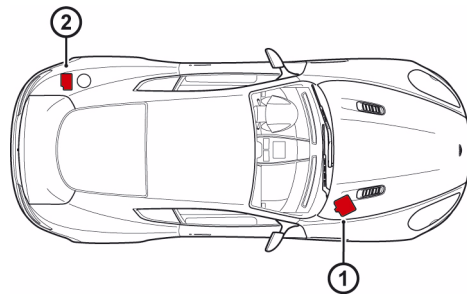

[1] : Engine bay fuse box (passenger side).

[2] : Boot fuse box.

Fuses**Engine Bay Fuse Box**

Fuse	Rating	Function
F1	10A	Keep alive power (PCM B)
F2	10A	Not available
F3	10	Not available
F4	20A	Engine management (PCM A)
F5	20A	Engine management (PCM B)
F6	15A	Exhaust gas oxygen (HEGO) and catalyst sensors (Bank B)
F7	15A	Ignition coils 7-12 (Bank B)
F8	10A	Not available
F9	20A	Fuel injectors 7-12 (Bank B)
F10	10A	Air conditioner compressor clutch

Fuse	Rating	Function
F11	15A	Horn
F12	10A	Keep alive power (PCM A)
F13	20A	Fuel injectors 1-6 (Bank A) / Oil level sensor
F14	10A	Not available
F15	25A	Starter motor solenoid
F16	15A	Ignition coils 1-6 (Bank A)
F17	5A	Not available
F18	15A	Exhaust gas oxygen (HEGO) and catalyst sensors (Bank A)
F19	30A	ABS module
F20	30A	ABS module
F21	30A	Not available

Fuse	Rating	Function
F22	5A	Mass air flow sensor (Bank B)
F23		Blank
F24	5A	Not available
F25	5A	Mass air flow sensor (Bank A) / Vapour management valve
F26	20A	Headlamp wash pump
F27	40A	Not available
F28	10A	ABS Module / Steering angle sensor / Vehicle key reader / Fuel tank diagnostic
F29	20A	Not available
F30	5A	Not available
F31	40A	Not available
F32	30A	Windscreen wiper motor (slow)

Fuse	Rating	Function
F33	30A	Windscreen wiper motor (Fast)
F34	15A	Steering column lock
F35	80A	Cooling fan module

Boot Fuse Box

Fuse	Rating	Function
F1	15A	Tonneau lid latch motors
F2	20A	Rear power outlet
F3	30A	Heated rear window
F4	20A	Rear left quarter glass motor
F5	30A	Audio amplifier
F6	20A	Rear right quarter glass motor
F7	5A	Convertible roof module
F8	30A	Fuel pump module (Bank B)
F9	30A	Fuel pump module (Bank A)
F10	30A	Convertible roof module
F11	20A	Satellite navigation / Satellite radio (when installed)

Headlamp

Fuse	Rating	Function
F12	20A	Automatic transmission module
F13	10A	Automatic transmission module
F14	5A	Parking assist / Adaptive damping
F15	5A	Exhaust bypass
F16	30A	Convertible roof pump
F17	5A	Boot lamps / Boot power socket illumination
F18	30A	Audio amplifier
F19	5A	Not available
F20	20A	Cubby box power socket
F21	30A	Tonneau lid latch motors
F22	20A	Not available

⚠ Warning: High Intensity Discharge (HID) bulbs produce a very high voltage. They should only be serviced by an Aston Martin Dealership.

 *Headlamp Units: Condensation: The headlamp units will generate condensation under certain conditions. However, this should clear after approximately 10 minutes.*

High Intensity Discharge (HID) bulbs are used for the combined main and dipped beam. HID systems produce a brilliant white light by establishing a high voltage electrical arc between two electrodes within a sealed glass tube. Once the arc is established, the voltage lowers to normal operating conditions.

HID bulbs are not renewable.

Contact to your Aston Martin Dealer if a HID bulb fails to operate.

Other External Lamps

 LEDs can last tens of thousands of hours and are resistant to heat, cold, shock and vibration.

High Level Stop Lamp

The high level mounted stop lamp unit consists of LEDs and is not repairable. If a high level mounted stop lamp LED fails contact your Aston Martin Dealer.

Front Indicator and Parking Lamps

If a front indicator or parking bulb fails to operate, contact your Aston Martin Dealer. These lamps consist of LEDs and are not repairable.

Side Indicators

The side indicators comprise of five LEDs in each front wing side strake and are not repairable. If a side indicator LED fails, contact your Aston Martin Dealer.

Registration Plate Lamps

Remove the trim panel from the underside of the boot lid.

Twist, counterclockwise, and withdraw the bulb holder. Remove the defective bulb and replace with a new one.

Twist the bulb holder back into in position. Replace the boot trim panel



Rear Lamp Clusters

The rear indicators, stop and tail, reversing lamps and rear fog LEDs are contained in a sealed lamp cluster unit, one either side of the vehicle. The lamp cluster is not repairable, if a rear lamp fails contact your Aston Martin Dealer.

Boot Lamps

Taking care not to damage the vehicle trim, lever out the lens unit (A). Twist, counterclockwise, and remove the bulb holder. Replace the defective bulb. Install the bulb holder and clip the lens unit into its housing.

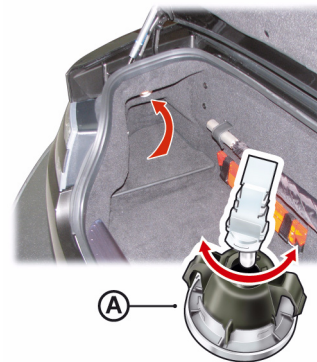

Internal Lamps

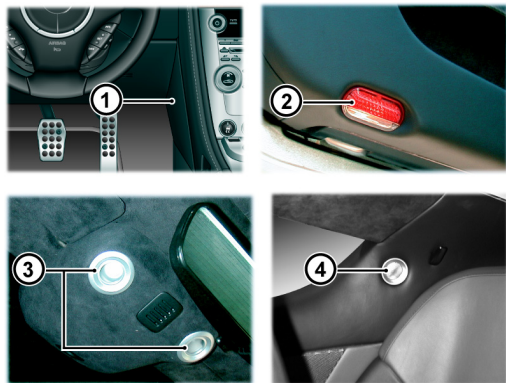

- [1] : Front footwell lamps: Type: W5W (Blue). Rating: 5W.
- [2] : Door puddle lamps: Type: C5W (Festoon). Rating: 5W.
- [3] : Front reading lamps: LED
- [4] : Rear quarter panel reading lamps: LED₁

LEDs are not repairable. If an LED lamp fails to operate, contact your Aston Martin Dealer.

To renew a bulb:

Take care not to damage the vehicle trim.

Lever out the lens unit and replace the faulty bulb. **Door puddle lamps only:** Open the access flap and replace the faulty bulb.

Press the lens unit into its housing until it clips into position.

₁. 2+2 seating only.

Tourist Headlamp Adjustment

The headlamp beams can be adjusted to give a flat beam. This prevents dazzling oncoming vehicles if driving in another country where the road priority changes, i.e. from driving on the right to driving on the left.

Remove the panel in each wheel arch liner. Turn the steering to the opposite lock from the headlamp unit. Using a flat blade, i.e. a screwdriver or a small coin, release the screw on the access panel and remove the panel.

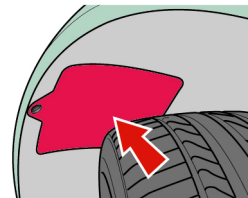

Remove the rubber cap and locate the headlamp adjust lever (A). Move the lever down to give a flat headlamp beam. Install the rubber cap and the wheel arch liner panel. Repeat for the other headlamp.

Remember to set the adjustment level back to normal beam (lever up) when back in your home country.

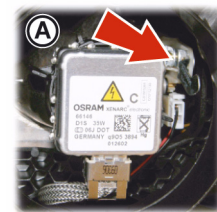

Door Window Reset

If power to the electric windows has been interrupted for any reason, they will fail to operate correctly until reset.

1. Sit in the driver's seat with all doors closed, insert the vehicle key into the ignition control and move to position 'II' (ignition ON).
2. Press firmly and hold the window switch until the window is at the maximum down position. Continue to hold the button for five seconds then release.
3. Pull back and hold the window switch until the window is in the maximum up position. Continue to hold the switch for a further five seconds, then release.
4. The window is now reset. Repeat for the other door windows.

Front Seat Reset

Should a front seat fail to move or the seat memory position fails to work this may show a loss of seat position in the vehicle's memory. If so, complete the seat reset procedure detailed below:

⚠ Warning: Make sure that there is nothing in front of, behind, or under the seat during adjustment.

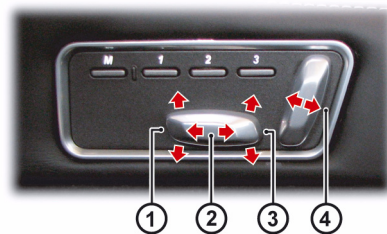

1. Press the seat forward button (2) until the seat is fully forward.
2. Press the seat back button (4) until the seat back is fully backwards₁.

₁. Sport seat only.

3. Press the seat down button (1) until the front of the seat is fully down.
4. Press the seat down button (3) until the rear of the seat is fully down.

The seat movement and position memory should now work correctly, if not contact your Aston Martin Dealer.

Bodywork Maintenance

Door drain holes

Check the drain holes in the bottom face of each door periodically and clear if necessary with, for example, a short length of wire or a pipe cleaner.

Vehicle Cleaning

Paint Work

Modern water based paints are much safer and more environmentally friendly than solvent based paints. Water based paints are however more susceptible to contamination and marking by corrosive substances. The following list is not exhaustive but does show the most common contaminants which may adversely affect your paint work:

 *Other groups of contaminants may be added to this list as experience of water based paints and finishes increases.*

- Bird Droppings
- Antifreeze
- Tree Sap
- Oils and Greases
- Insect Remains

Wash such substances from the vehicle using clean warm water with vehicle shampoo, at the earliest opportunity, especially in sunny weather which can accelerate contamination.

Washing

⚠ Warning: Washing and polishing agents containing silicone should not be applied to glass. This will reduce the efficiency of the windscreen wipers, causing smears which will reduce visibility, particularly during darkness and in the rain.

⚠ Commercially operated automatic vehicle washes, jet washes and power operated mops are not recommended. The detergents used can contain certain chemicals which may, over time, be detrimental to some exterior parts of the vehicle. Prolonged usage of automatic vehicle washes and power operated mops will also cause fine scratches in the paint surface.

Aston Martin recommends the use of AUTOGLYM vehicle care products or preparations of similar reputable manufacture for adding to the washing water. Make sure that the manufacture's instructions are followed.

During the winter months, it is advisable to wash the vehicle more frequently, paying particular attention to the underside to combat the detrimental effects of any salt and sand contamination picked up from treated roads.

To delay the onset of corrosion developing on the brake components Aston Martin recommend that after washing this vehicle, the vehicle should be driven a short distance to make sure that all the water and washing product has dried off.

For best results:

Do not wash the vehicle in strong sunlight. Let the vehicle cool before washing.

Do not use household soaps or detergents.

Do not direct water hoses at full force around the door and boot lid seals.

Do not use a brush on the car body as this will leave little scratches.

Suggested washing method:

1. Fill two buckets with water. To one bucket add a mild neutral detergent, as directed by the detergent manufacturer.
2. Hose the vehicle to remove all dust and mud residue. Don't use a strong jet, as this can rub grit over the paint and scratch it.

3. Soak a large wash mitt or a soft sponge in the soapy water, make sure to wash out any dirt in it, and begin applying it to the vehicle. Wash the vehicle section by section, starting at the top. Circle around the car several times, washing lower areas with each round.
4. Rinse the dirt out of the wash mitt or soft sponge in the bucket with plain water frequently.
5. After one section is washed, rinse it with the hose before moving on, don't let the soap dry on the paint and stain it. Always keep the vehicle wet, this will prevent droplets from drying on the paint and leaving water-spots.
6. Dry the car with a chamois leather before it air-dries.

Front Grill

Wash and clean the vehicle's front grill in the same way as the paint work, but make sure that the front grill is dried off completely leaving no water droplets on the grill (wipe the front grill last using a chamois leather): Chrome polish or other abrasive cleaners must not be used.

Road Wheels

To avoid possible damage to the alloy road wheels, wheel nuts & wheel centre trims, from a build up of brake dust wash and clean the alloy road wheels frequently, using a mild soapy water solution only. Do not use chemical alloy road wheel cleaners, as they can often have a high acid or alkaline content and could cause discolouration. Always clean one wheel at a time and do not allow the cleaning solution to dry on the wheel. Fully flush off with clean water.

Ceramic Brake Discs

To avoid possible damage to the ceramic brake discs, when washing the road wheels with products or materials other than a mild soapy water solution always remove the wheels from the vehicle.

Headlamp Lenses

Only use a mild soapy water solution when washing the Headlamp Lenses. Do not use cleaning materials which contain solvents. Cleaning materials which contain solvents, i.e. tar remover, petrol, waxes or polishes, may damage the headlamp lens.

Polishing

Approximately twice a year, a good quality polish should be applied to the body work and then buffed, using a soft lint free cloth.

The alloy wheel rims should be treated with a cleaner which is specifically manufactured for this purpose.

Upholstery, Trim, Carpets and Seats

⚠ Warning: Fumes from cleaning solvents may be dangerous in confined spaces. Make sure that the vehicle is well ventilated and follow the manufacturer's printed instructions when using these products.

⚠ Certain types of clothing, such as denim and vegetable tanned leather, are prone to 'dye transfer'. This can cause discolouration in the leather. Make sure that the affected areas are cleaned and re-protected as soon as possible.

The seats and soft trimmed components of this vehicle are covered in hand crafted leather. In order to maintain the beauty of leather it will require regular cleaning, which, if neglected, may cause deterioration. Where dust and dirt are allowed to accumulate and become ingrained in the surface the leather may become permanently damaged. Leather faced features should be cleaned with a with a damp cloth moistened with an undiluted leather cleaner.

Do not use detergents, quick cleansers or furniture polishes. These products may give an initially impressive result, but their use will lead to rapid deterioration of the leather and will invalidate the warranty. Several times a year, a leather conditioner or preservative should be used. Appropriate care materials are obtainable from your Aston Martin Dealer.

Alcantara roof linings and other soft trimmed areas may be brushed with a soft brush. Stains from water based substances such as coffee, tea or soft drinks should be cleaned as soon as possible with mild soap and water.

The brushed and anodised aluminium trim should be cleaned using a dry clean lint free cloth.

Consult your Aston Martin Dealer for instructions on the removal of more difficult stains such as oil, grease or ballpoint ink.

Carpets should be cleaned regularly with a vacuum cleaner. Any stains or grease marks should be removed with a good quality solvent suitable for use on carpets.

Care and Maintenance of Seat Belts

⚠ Do not allow seat belts to be retracted until they are completely dry.

To make sure that the restraint webbings are in correct working order, regularly check the seat belts. Look for fraying, cuts, burns and similar problems. Make sure that the latches and buckles operate correctly. If a seat belt is not in good condition or is not working correctly, consult your Aston Martin Dealer.

Any seat belt that has been worn during a serious collision should be replaced by an Aston Martin Dealer.

To clean the seat belts, use mild soap and water; do not use bleach, solvents or dyes as they can weaken the material. Allow the seat belts to dry thoroughly before use.

Convertible Roof Fabric

! *Do not use automatic vehicle washes. Brushes, detergents and pressurised water jets may damage the roof fabric. Do not use power washers. Jets of water may damage the weather seals and the roof fabric. Do not use spot cleaners, chemical diluents or any organic cleaners. If in doubt, contact your Aston Martin Dealer.*

To maintain the appearance and condition of the roof fabric the cleaning and reproof recommendations given below should be followed. This is of particular importance in the case of light coloured roof fabrics.

 *Do not leave the roof in the lowered (folded) position for longer than necessary. In certain circumstances permanent soiling along folds may occur.*

Cleaning

Always remove bird droppings as soon as possible. The organic acids in bird lime can adversely affect the roof fabric.

Carefully vacuum clean the roof fabric to remove any loose particles. Gently, and evenly, wash the roof fabric using a mild soap solution and a soft brush.

 *A hard brush will damage the fabric fibres.*

Rinse the roof fabric thoroughly with clean water to remove any traces of soap. Allow the roof fabric to completely dry before operating the roof.

Reproofs

Due to its construction the roof fabric will stay watertight without re-proofing. However to retain the appearance of the roof, to reduce soiling and to improve the drying time Aston Martin recommended that the roof is re-proofed annually, by your Aston Martin Dealer.

Under Bonnet Cleaning

Under bonnet cleaning using high pressure hoses or steam cleaners should not be carried out. The electronic control module connections and fuse boxes can be damaged by indiscriminate use of high pressure cleaning equipment.

Vehicle Storage

Recommendations

 *These recommendations apply to new and pre-owned vehicles either in dealer or customer ownership.*

If your vehicle is not to be used for periods in excess of three months it should be stored in a dry, well ventilated building.

1. Drive the vehicle for a sufficient distance to warm the oil in the engine and the transaxle; make sure that the internal components of the engine are lubricated.
2. Check the engine coolant level. Top up if necessary with the correct antifreeze and water solution.
3. In order to take the weight off the tyres, raise the vehicle with a jack and place supports under the front and rear suspension. If the vehicle is not raised from the ground, increase the tyre pressures to 3.4 bar. Cover the tyres to exclude any light. Turn the wheels ¼ turn every month to avoid tyre flat spots.
4. Raise the roof¹.

¹. Volante only.

 Do not leave the roof in the lowered position for longer than necessary. In certain circumstances permanent soiling along folds may occur.

5. If mains power is available, use a battery conditioner to maintain the battery in a fully charged state.
6. Once a month:
 - 6.1 Disconnect the battery conditioner (if installed).
 - 6.2 Start and operate the engine until it is fully warmed up.
 - 6.3 Check there are no fluid leaks.
 - 6.4 Set the ignition to OFF.
 - 6.5 Connect a battery conditioner.
 - 6.6 Check and correct tyre pressures if necessary. When returning the vehicle to normal service, set the tyre pressures to normal specification before driving on the road.

Extended Storage

For storage periods exceeding six months the following measures are recommended:

 Do Not Drain Fuel System.

1. Operate the engine until there is as small a quantity of fuel in the tank as is practical for storage purposes.
2. Add engine oil to the remaining fuel in the tank to make a concentration of 2% (i.e. 20 ml per one ltr of fuel), then operate engine for not less than ten minutes to circulate the mixture thoroughly through all of the fuel system.
3. Inspect rubber connections of coolant system and have them renewed if necessary.
4. Wash the vehicle bodywork thoroughly and repair any paint blisters or patches of corrosion in order to prevent any further deterioration. Apply a suitable polish.
5. Clean the carpets and upholstery thoroughly. Treat all leather upholstery with an application of a leather conditioner or preservative.

6. If the storage building is dry leave vehicle windows slightly open. If there is any tendency towards dampness close vehicle doors and windows and place an anti-moisture compound such as silica desiccant bags in an open metal container inside vehicle.
7. Cover vehicle with a cotton or fabric cover.

Recommissioning after Storage

Provided that the vehicle has been stored in accordance with the recommended procedure, only the following points should need attention before using your vehicle on the road.

 **Starting the engine without sufficient lubrication can cause serious engine damage. Make sure that the engine oil pressure is established before the engine starts.**

1. Check the tyre pressures, inflate if necessary, lower the vehicle to ground.
2. Drain the engine oil and install a new engine oil filter element. Fill the engine to its maximum level (as shown on the dip stick) with approved oil.
3. Drain the final drive unit. Fill the final drive unit to its maximum level (oil will dribble out of the fill hole), with approved oil.

4. Check the coolant level and, if necessary, top up with the correct antifreeze to water solution.
5. Check all fluid levels and top up as necessary.
6. Fill the fuel tank.

! Starting the engine without sufficient lubrication can cause serious engine damage. Make sure that the engine oil pressure is established before allowing the engine to start.

7. Obtain engine oil pressure:
 - 7.1 Press and hold the accelerator pedal hard to the floor (this temporarily stops fuel injection during cranking).
 - 7.2 Fully press the brake pedal down. Insert the vehicle key into the ignition control and move through to engine start. Let the engine to crank until the oil pressure symbol  (in the instrument cluster) goes OFF (showing oil pressure in the engine).
 - 7.3 Set the ignition to OFF. Release the vehicle key and accelerator pedal.

8. Start the engine normally and check that the oil pressure and ignition warning symbols go OFF as the engine starts (correct oil pressure and battery charging).
9. Raise the bonnet and check for leaks of fuel, oil and coolant.
10. Check the operation of the roof and check for oil leaks. If the roof does not operate correctly during first use, operate the roof a few times (with the engine running to keep the battery at full voltage). If the roof still does not operate correctly contact your Aston Martin Dealer¹.
11. Carefully test drive your vehicle and check the operation of all functions.

If in any doubt about the condition of your vehicle, have it checked by your Aston Martin Dealer.

¹. Volante only.



ASTON MARTIN

Specifications

Engine.....	12.2	Wheels.....	12.4
Performance	12.2	Tyres	12.5
Power and Torque	12.2	Bulbs.....	12.6
Transmission	12.3	Vehicle Specification	12.6
Electrics.....	12.3	Vehicle Weights	12.6
Steering.....	12.3	Interior Dimensions.....	12.7
Suspension.....	12.4	Exterior Dimensions	12.7
Brakes.....	12.4	Vehicle Features.....	12.8
		Fluids and Capacities.....	12.9

Engine

All alloy, quad overhead cam 48 valve V12

Fuel: Recommended 98 RON Super Unleaded for optimum performance. 95 RON minimum.

Fuel Delivery System: Multi point sequential fuel injection.

Capacity: 5935 cc

Firing Order: 1 - 7 - 5 - 11 - 3 - 9 - 6 - 12 - 2 - 8 - 4 - 10

Idle Speed: 650 rpm

Bore: 89.0 mm

Stroke: 79.5 mm

Spark Plugs: NGK: PTR6E-13

Spark Plug Gap: 1.3 mm \pm 0.1 mm

Compression Ratio: 11.0:1

Ignition: 'Coil on Plug' ignition system

Emission Control: Eight Oxygen sensors (four per exhaust branch).

Two three-way catalytic convertors (one per exhaust branch).

Evaporative loss purge

Lubrication: Wet sump pressurised lubrication

Performance

Maximum Power: 365.4 kw @ 6000 rpm

Maximum Torque: 570.0 Nm @ 5750 rpm

Maximum Speed: 295.0.0 km/h₁₂

0-100 km/h: 4.5 seconds

Maximum Engine Speed: 6850.0 rpm

Power and Torque

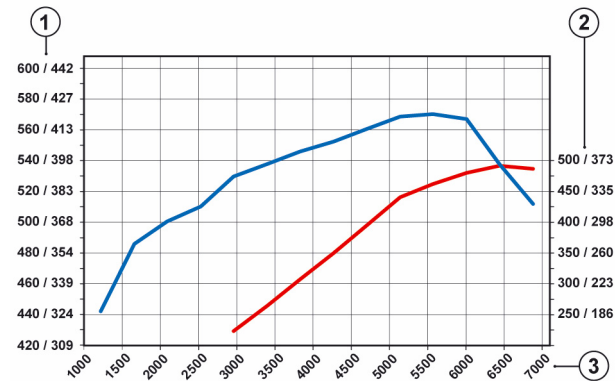

[1] : Torque (Nm / lb/ft)

[2] : Power (kw / bhp)

[3] : Engine speed (rpm)

1. Where permitted.
2. Electronically restricted.

Transmission

Automatic Transmission

ZF 6HP26 six speed with 'Shift by Wire' (SBW) gear shift technology.

Gear Ratios

1st	4.17:1
2nd	2.34:1
3rd	1.52:1
4th	1.14:1
5th	0.87:1
6th	0.69:1
Reverse	3.40:1

Final Drive

Ratio: 3.46:1. Limited slip differential

Electrics

Alternator: Denso SC5 200 Amps

Voltage Regulation: 14.4V \pm 0.5V @ 20°C

Battery: Varta 90 AH

Steering

Rack and pinion, servotronic speed sensitive power assisted steering. Column tilt and reach adjustments.

Turns lock to lock: 3.0

Turning Circle: 11.5 m (Kerb to Kerb)

Toe₁:

Total Toe

Front (Toe In)

-0.8' (\pm 4')

Rear (Toe In)

0.20' (+0.10' / -0.0')

¹. With the vehicle at its Design Weight. Refer to your Aston Martin Dealer.

Suspension

Front: Aluminium independent double wishbone incorporating anti-dive geometry. Coil over aluminium monotube dampers and anti-roll bar.

Rear: Aluminium independent double wishbone incorporating longitudinal control arms. Coil over aluminium monotube dampers and anti-roll bar.

Features

- Dynamic Stability Control (DSC)
- Adaptive damping system (ADS)

Brakes

Footbrake

Ventilated Carbon Ceramic Discs

	Front	Rear
Diameter	398 mm	360 mm
Callipers	Six piston	Four piston

Park Brake

Lever and cable operated independent park brake callipers on each rear brake disc.

Brake System Features

- Anti Lock Braking System (ABS)
- Hydraulic Brake Assist (HBA)
- Electronic Brake force Distribution (EBD)
- Traction Control (TCS)

Wheels

Aston Martin Aluminium Alloy

Front	Rear
8.5j x 20"	11j x 20"

Aston Martin Lightweight Forged Aluminium Alloy¹

Front	Rear
8.5j x 20"	11j x 20"

¹. Option.

Wheel Nut Torque

Tighten every second nut until all five nuts are tightened. Tighten all wheel nuts in two stages.

1. To 80 Nm in one continuous movement.
2. To 180 Nm in one continuous movement.



Tyres

Tyre Loading

Tyres installed to this vehicle shall have a maximum load rating not less than 690 kg (front) and 825 kg (rear), or a load index of 95 (front) and 101 (rear) and a speed category of 'Y'.

Summer Tyres

 The original equipment tyres, including winter tyres, installed to this vehicle are an approved specification, designated by 'AMS' on the sidewall.

	Front	Rear
Pirelli P-Zero Corsa	245/35 R20	295/30 R20

Winter Tyres

	Front	Rear
Pirelli W270 Sotto Zero	245/35 R20 95W XL	295/30 R20 101W XL

Tyre Air Pressures

Cold Inflation¹

Front	Rear
2.5 bar	2.6 bar

¹. All Tyres.

Bulbs

	Rating	Type
Headlamp dipped beam	35W	D1S HID
Headlamp main beam	65W	H9
Front indicator lamps		LED
Parking, registration plate, footwell, side marker (front and rear) and rear environment (Blue) lamps	5W	W5W
Door lamps	5W	C5W
Boot lamps	3W	W3W
Side repeater		LED
Rear quarter lamps and reading lamps		LED
High Mounted Stop Lamp		LED

The rear lamp cluster is a sealed unit. If any rear cluster lamp fails to operate contact your Aston Martin Dealer.

Vehicle Specification

Body

- Two door coupe with 2+2 or 2+0 seating
- Two door volante with 2+2 or 2+0 seating

Extruded aluminium bonded monocoque. Aluminium, composite and carbon fibre composite skin panels. Extruded aluminium door side impact beams.

Towing

This vehicle is not engineered to tow any form of caravan, boat or trailer.

No towing devices are approved to install to this vehicle, other than a front towing eye to aid recovery or loading of this vehicle onto a transporter.

Vehicle Weights

Kerb Weight

Coupe:	1785 kg
Volante:	1890 kg

Gross Vehicle Weight (GVW)

Coupe:	2085 kg
Volante:	2190 kg

Boot Maximum Load

40 kg¹

¹. Evenly distributed

Interior Dimensions

	Front	Rear
Effective Headroom		
Coupe:	932 mm	796 mm
Volante:	921 mm	800 mm
Effective Legroom		
Coupe:	1086 mm	695 mm
Volante:	1086 mm	676 mm
Hip Room	1410 mm	1242 mm
Boot Volume		
Coupe:	186 ltr	
Volante:	138 ltr	

Exterior Dimensions

(mm / inch)

 Ride height is measured at GVW.

Coupe

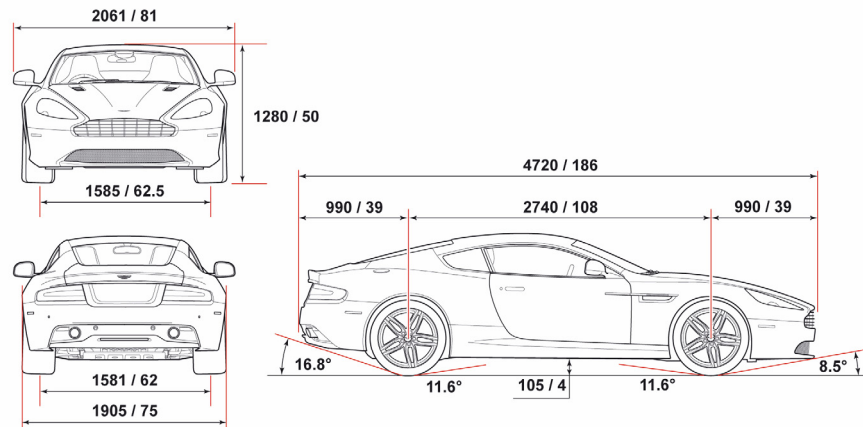

Vehicle Features

Volante

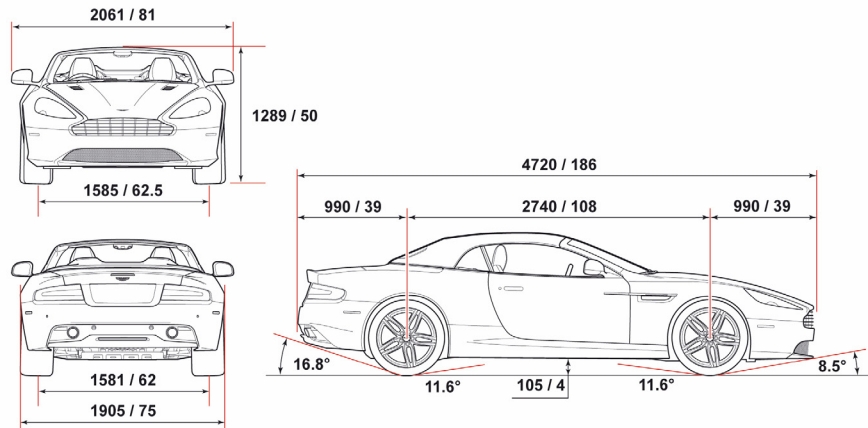

Interior

- Handcrafted leather and fabric trim
- Walnut facia veneer¹
- Polished aluminium and painted alloy details
- Climate control
- Security system interacting with the central locking system and PATS immobiliser system
- Driver and front passenger dual stage front airbags
- Front passenger side airbag²
- Lightweight seats with manual lumbar adjustment³
- Ten direction electrically adjusted front seats (including height adjustment)⁴
- Position memory front seats (including door rear view mirrors)
- Heated seats (two heat levels)¹.
- Organic electroluminescent (OEL) displays

1. Options.
2. Sport Seats Only.
3. Option: 2+0 seating only.
4. Option.

- Infotainment centre
 - Aston Martin Audio system with radio, 6 CD autochanger and 700W power output with Dolby Pro Logic II₁.
 - Bang & Olufsen audio system with radio, 6 CD autochanger and 974W power output₁.
 - Hands-free phone system
 - Garmin satellite navigation system

Exterior

- Door mirrors
 - Heated, electrically adjusted
 - Position memory system
 - Power fold system
 - Auto fold system
- Electrically operated door windows
- Heated rear window
- Parking assist sensors

Fluids and Capacities

Recommended Fluids

! *To achieve the required high performance of synthetic lubricants, do not mix with mineral oils.*

Engine Oil: Mobil 1 Recommended 0W-40. However, if this oil is not available a fully synthetic 0W-40 oil meeting the specifications detailed below can be used. No other viscosity grades or specifications are acceptable.

Authority	Standard
API	SL / SJ / EC / CF
ACEA	A3 / B3 / B4
ILSAC	GF3

! *Do not mix OAT antifreeze with glycol based antifreeze.*

Engine Coolant: 50% water, 50% Havoline OAT

Automatic Transmission Fluid: Shell ATFM 1375-4

Automatic Transmission Final Drive Oil: Shell Spirax ASX 75W-90

Brake Fluid: Castrol Response Super Dot 4

Power Steering Fluid: Pentosin CHF 11S

Air Conditioner Refrigerant: HFC134A

Capacities

Engine Sump (including filter): 11 ltr

Automatic Final Drive and Cooler: 1.6 ltr

Engine Cooling System: 15 ltr

Power Steering Reservoir: 1.3 ltr

Screen Washer Reservoir: 6.9 ltr

Fuel Tank: 80.0 ltr₁

₁. Approximately 78.0 ltr usable.



ASTON MARTIN



ASTON MARTIN



ASTON MARTIN



Service

Pre-delivery Inspection	A.2
Servicing	A.5
Service Record	A.8
Brake Disc Check.....	A.10
Anti Corrosion Inspection	A.12
Replacement of Airbag Units	A.14
Replacement of Seat Belt Pre-tensioners.....	A.14
Field Service Actions	A.14
Service Action Recalls.....	A.15

Pre-delivery Inspection

This free series of checks is carried out on the vehicle by the Selling Dealer before delivery. The checks make sure that you receive a vehicle which matches the high quality standards set by Aston Martin Limited.

The list below applies to all Aston Martin vehicles. Your Aston Martin may or may not have all or some of the functionality listed.

Make sure that the entry is stamped and signed as completed. The following checks will be made:

Levels and Leaks

- Engine oil
- Power steering oil
- Brake fluid
- Clutch fluid
- Engine coolant level
- Engine coolant specific gravity
- Windscreen washer fluid
- Fuel system
- Transaxle leak check
- Lift glass
- Battery

Mechanical Functions

- Gear selection
- Clutch operation
- Throttle pedal operation
- Park brake operation
- Steering column adjustment and lock operation
- Seat adjuster rails
- Bonnet release and catch
- Door operation and locks
- Storage compartments
- Rear view mirror
- Boot release and catch
- Lift glass release and catch
- Seat belt operation

Electrical Checks

- Battery condition
- Gear selection
- Heated rear window
- Windscreen and headlamp washers
- Windscreen wipers
- Climate control
- Infotainment centre operation
- All speakers
- Reversing, registration plate and brake lamps
- Side and headlamps
- Rear fog lamps
- Hazard warning lamps
- Instrument illumination and dimmer
- Gauges and warning symbols
- Centre stack controls
- Horns

-
- Reset clock
 - Blower motor
 - Seat belt warning system
 - Security system and vehicle key
 - Interior lamps
 - Cigar lighter₁
 - All seat functions
 - Door window mechanisms
 - Door and boot lamps
 - Central locking system
 - Filler flap lock operation
 - Clutch pedal start inhibit
 - Door mirror adjustments
 - Interrogate fault codes
 - Record battery open-circuit voltage
 - Tyre pressure sensing
 - Centre console controls
-

¹. Option.

Wheels and Tyres

- Install locking road wheel nuts₂
- Check road wheel nuts torque
- Tyre pressures
- Tyre orientation

Road Test

- Engine
 - Clutch
 - Transaxle
 - Steering
 - Brakes
 - Wheel balance
 - Adaptive dampers
 - Dampers
 - Exhaust by-pass system
-

². Option.

- Gear shift operation
- Noise, vibration or harshness
- Climate control performance
- Instruments operation
- Seat belt and buckle operation
- Steering wheel alignment
- Dynamic stability control, traction control, adaptive damping and anti-lock braking system operation
- Transmission oil cooler

Final Checks

- Drive belt tensioner operation
- Fuel and brake pipe security
- Fuel and fluid leaks
- Security of cooling hoses
- Exhaust catalyst security

Hand-over Preparation

- Check function of locks and vehicle keys
- Clean bodywork and road wheel arch liners.
- Clean off all transit labels
- Valet vehicle
- De-grease windscreen
- Install carpets
- Remove interior protection
- Check Owner's Guidebook
- Check tools
- Install Registration plates
- Tyre sealant kit
- Towing eye
- Battery conditioner₁
- Field Service Actions and Recall status

₁. Option.

Free Pre-delivery Inspection

*4.75 Hours

Service Actions checked:

Open Service Actions completed:

Signature:

Date:

(Dealer Stamp)

* Scheduled operation time.

Servicing

Service Periods

Vehicle servicing is every 10,000 m or 12 month, which ever occurs first.

- 10,000 m or 12 month
- 20,000 m or 24 month
- 30,000 m or 36 month

Service Tables

The following service schedules are recommended for this vehicle. The schedules may be modified if necessary. Please consult your Aston Martin Dealer for details of any service schedule updates.

10,000 m / 12 month	20,000 m / 24 month	Item
Pre-Maintenance		
x	x	Install vehicle protection kit and wing covers
x	x	Check bulletins, field service actions and recall status

10,000 m / 12 month	20,000 m / 24 month	Item
Fluids, Filters and Leaks Checks		
x	x	Renew engine oil
x	x	Renew engine oil filter
x	x	Check for engine oil leaks
-	x	Renew air cleaner elements
x	-	Check transmission and final drive for leaks. Top up if required
Every 100,000 m or five years		
x	x	Renew engine coolant - check concentration
x	x	Check engine coolant level. Top up if required
x	x	Check cooling and heating systems for leaks
x	x	Check fuel hoses, pipes and unions for leaks, security and condition
Every 12 Months		
x	x	Renew brake fluid
x	x	Check power steering and brake fluid reservoir. Top up if required
x	x	Check power steering system for leaks, security and condition
x	x	Check brake hoses, pipes and unions for leaks, security and condition

10,000 m / 12 month	20,000 m / 24 month	Item	10,000 m / 12 month	20,000 m / 24 month	Item
x	x	Check suspension dampers for leaks	x	-	Check wiper blade inserts. Renew if necessary
x	x	Top-up windscreen and headlamp washer reservoir	-	x	Renew wiper blades
x	x	Check exhaust system for leaks	x	x	Inspect coolant radiator, air conditioning condenser and transmission cooler. Clean if required
x	x	Check operation of exhaust by-pass valves			
x	x	Check Air Conditioning system for leaks	x	x	Check condition and operation of all seat belts
-	x	Renew pollen filter	x	x	Check security of exhaust system mountings and heat shields
Mechanical Function Checks			x	x	Check cooling system hoses security and condition
x	x	Lubricate all door locks and hinges	x	x	Check Air Conditioning hoses security and condition
x	x	Lubricate bonnet secondary catch	x	x	Check security and condition of suspension ball joints, gaiters and bushes
x	x	Check security of the bonnet catch. Check that the bonnet secondary catch moves freely over its whole travel and returns smartly under spring pressure.	-	x	Check tightness of drive shaft bolts
x	x	Check and adjust the accessory drive belt tension. Renew if necessary	x	x	Check rear view mirrors for security and function
x	x	Check park brake security	-	x	Check condition of underbody protection and wheel arch liners
x	x	Check condition of park brake pads	Every 40,000 m or four years		Clean throttle butterflies
x	x	Inspect brake pad wear and condition of discs and callipers. Replace brake pads and wear warning leads if 60% worn. Check front brake disc shields for fatigue and for clearance to discs.			

10,000 m / 12 month	20,000 m / 24 month	Item
Electrical Function Checks		
		70,000 m
x	x	Renew spark plugs
x	x	Check and record battery voltage
x	x	Clean and service the battery connections if required
-	x	Check headlamp alignment. Adjust if required
x	x	Check operation of all lamps
x	x	Check operation of all warning symbols
x	x	Check audible warnings including security system
x	x	Check operation of the horns
x	x	Check operation of the windscreen wipers
x	x	Check windscreen and headlamp washers and jets
x	x	Check rear view mirrors for security and function
x	x	Check and operate powerfold mirrors
x	x	Check and operate electric windows
x	x	Check service interval display. Reset
-	x	Replace vehicle key battery
x	x	Replace tracker tags

10,000 m / 12 month	20,000 m / 24 month	Item
Wheels and Tyre Checks		
x	x	Check for correct tyre size, type and orientation
x	x	Check and report tyre tread depth
x	x	Check tyres for uneven, excessive wear or damage
x	x	Check and adjust tyre pressures
x	x	Check torque of road wheel nuts
x	x	Check road wheel rims for inner and outer damage.
x	x	Check operation of tyre pressure sensors
x	x	Check 'use by' date of tyre repair kit.
Anti Corrosion Check		
x	x	Check body panels and underbody for corrosion starting from the inside - out (excluding stone chips).

10,000 m / 12 month	20,000 m / 24 month	Item
Gear Change Modes		
x	x	Auto Drive
x	x	Touchtronic
x	x	Reverse
x	x	Sport
Final Checks		
x	x	Degrease windscreen
x	x	Carry out road test
x	x	Check ABS, adaptive damping and traction control operation
x	x	Check that fuel filler bowl rain drain is clear

Service Record

The following service records cover the regular services at 10,000 m or 12 month, which ever occurs first, intervals. Make sure that at each service the appropriate entry is stamped and signed as completed.

Vehicle Identification Number (VIN):

Date of Delivery:

* Scheduled operation time.

10,000 m or 12 month	
*3.85 Hours	
Service Actions checked:	
Open Service Actions completed:	
Signature:	
Date:	Odometer:
Dealer Stamp	

20,000 m or 24 month

*5.00 Hours

Service Actions checked:
_____Open Service Actions completed:
_____Signature:

Date: _____

Odometer: _____

Dealer Stamp

40,000 m or 4th year

*5.00 Hours

Service Actions checked:
_____Open Service Actions completed:
_____Signature:

Date: _____

Odometer: _____

Dealer Stamp

60,000 m or 6th year

*5.15 Hours

Service Actions checked:
_____Open Service Actions completed:
_____Signature:

Date: _____

Odometer: _____

Dealer Stamp

30,000 m or 3rd year

*3.85 Hours

Service Actions checked:
_____Open Service Actions completed:
_____Signature:

Date: _____

Odometer: _____

Dealer Stamp

50,000 m or 5th year

*3.85 Hours

Service Actions checked:
_____Open Service Actions completed:
_____Signature:

Date: _____

Odometer: _____

Dealer Stamp

70,000 m or 7th year

*6.30 Hours

Service Actions checked:
_____Open Service Actions completed:
_____Signature:

Date: _____

Odometer: _____

Dealer Stamp

80,000 m or 8th year

*5.00 Hours

Service Actions checked:
_____Open Service Actions completed:
_____Signature:

Date: _____ Odometer: _____

Dealer Stamp

90,000 m or 9th year

*4.05 Hours

Service Actions checked:
_____Open Service Actions completed:
_____Signature:

Date: _____ Odometer: _____

Dealer Stamp

100,000 m or 10th year

*5.20 Hours

Service Actions checked:
_____Open Service Actions completed:
_____Signature:

Date: _____ Odometer: _____

Dealer Stamp

Brake Disc Check

At each brake pad change (per axle), the ceramic brake discs are required to be cleaned, dried and weighed. Record the date of each brake pad change and disc weight.

Brake Pads Changed - Brake Discs checked

Front axle / Rear axle / All axles (delete as required)

Disc weight (front axle): _____ kg _____ kg

Disc weight (rear axle): _____ kg _____ kg

Odometer: _____

Signature: _____ Date: _____

(Dealer Stamp)

Brake Pads Changed - Brake Discs checked

Front axle / Rear axle / All axles (delete as required)

Disc weight (front axle): kg kg

Disc weight (rear axle): kg kg

Odometer:

Signature: Date:

(Dealer Stamp)

Brake Pads Changed - Brake Discs checked

Front axle / Rear axle / All axles (delete as required)

Disc weight (front axle): kg kg

Disc weight (rear axle): kg kg

Odometer:

Signature: Date:

(Dealer Stamp)

Brake Pads Changed - Brake Discs checked

Front axle / Rear axle / All axles (delete as required)

Disc weight (front axle): kg kg

Disc weight (rear axle): kg kg

Odometer:

Signature: Date:

(Dealer Stamp)

Brake Pads Changed - Brake Discs checked

Front axle / Rear axle / All axles (delete as required)

Disc weight (front axle): kg kg

Disc weight (rear axle): kg kg

Odometer:

Signature: Date:

(Dealer Stamp)

Brake Pads Changed - Brake Discs checked

Front axle / Rear axle / All axles (delete as required)

Disc weight (front axle): kg kg

Disc weight (rear axle): kg kg

Odometer:

Signature: Date:

(Dealer Stamp)

Brake Pads Changed - Brake Discs checked

Front axle / Rear axle / All axles (delete as required)

Disc weight (front axle): kg kg

Disc weight (rear axle): kg kg

Odometer:

Signature: Date:

(Dealer Stamp)

Anti Corrosion Inspection

Brake Pads Changed - Brake Discs checked

Front axle / Rear axle / All axles (delete as required)

Disc weight (front axle): kg kg

Disc weight (rear axle): kg kg

Odometer: _____

Signature: _____ Date: _____

(Dealer Stamp)

Anti Corrosion Inspection 1st Year

Signature: _____

Date: _____

Odometer: _____

(Dealer Stamp)

Anti Corrosion Inspection 3rd Year

Signature: _____

Date: _____

Odometer: _____

(Dealer Stamp)

Brake Pads Changed - Brake Discs checked

Front axle / Rear axle / All axles (delete as required)

Disc weight (front axle): kg kg

Disc weight (rear axle): kg kg

Odometer: _____

Signature: _____ Date: _____

(Dealer Stamp)

Anti Corrosion Inspection 2nd Year

Signature: _____

Date: _____

Odometer: _____

(Dealer Stamp)

Anti Corrosion Inspection 4th Year

Signature: _____

Date: _____

Odometer: _____

(Dealer Stamp)

Anti Corrosion Inspection 5th Year
Signature: _____
Date: _____
Odometer: _____

(Dealer Stamp)

Anti Corrosion Inspection 7th Year
Signature: _____
Date: _____
Odometer: _____

(Dealer Stamp)

Anti Corrosion Inspection 9th Year
Signature: _____
Date: _____
Odometer: _____

(Dealer Stamp)

Anti Corrosion Inspection 6th Year
Signature: _____
Date: _____
Odometer: _____

(Dealer Stamp)

Anti Corrosion Inspection 8th Year
Signature: _____
Date: _____
Odometer: _____

(Dealer Stamp)

Anti Corrosion Inspection 10th Year
Signature: _____
Date: _____
Odometer: _____

(Dealer Stamp)

Aston Martin Warranty

1 Vehicle Warranties.....	B.2	Owner Details.....	B.6
2 Warranty Period.....	B.2	Vehicle Details.....	B.6
3 Who May Repair the Vehicle.....	B.3	Owner Warranty Transfer (3).....	B.7
4 Wear and Tear Items.....	B.3	Owner Warranty Transfer (2).....	B.7
5 What is Not Covered.....	B.4	Owner Warranty Transfer (1).....	B.7
6 Customer Responsibility.....	B.5	Owner Warranty Transfer (6).....	B.9
9 Consumer Law.....	B.5	Owner Warranty Transfer (5).....	B.9
		Owner Warranty Transfer (4).....	B.9

1 Vehicle Warranties

Aston Martin gives a Warranty for each new Aston Martin vehicle and each replacement vehicle or assembly manufactured or supplied by the Company to be free from defects in material and workmanship under normal use and service for the applicable Warranty period.

The warranties provided herein are for the benefit of the original purchaser and any subsequent owner during the relevant Warranty Period (defined below) in the Serviced Countries (defined below).

An Aston Martin vehicle is built and homologated to support the Region for which it is manufactured and is compliant with the local regulatory requirements of that Region. As a result, the warranties cover Aston Martin vehicles that are built for and supplied to the Region.

For the purposes of this Owner's Guide, Region means one of the following territories:

- the Americas, including the United States, Canada, and South America; or
- the United Kingdom, Europe, Russia and South Africa; or
- the Middle East, North Africa and India; or
- Asia Pacific, including China, Japan, Taiwan, Hong Kong, Singapore, Australia and New Zealand.

'**Serviced Countries**' means either: (a) any country in the Region from which your Aston Martin vehicle was purchased, where there is an Aston Martin authorised dealer or repairer; or (b) any country agreed in writing with Aston Martin.

 *Tyres are covered separately by the tyre manufacturer. Dealers are expected to offer assistance to the customer in pursuing a claim against the tyre manufacturer.*

1.1 Exchange Parts Under Warranty

New parts will only be used for repairs at PDI and during the first three months or 5000 km (which ever occurs first) from the date the vehicle is handed over to the first retail customer. Thereafter exchange parts must be used where available under Aston Martin's exchange plan.

1.2 Anti Perforation Corrosion Protection Warranty

The vehicles bodywork is protected by an Anti Perforation Corrosion Warranty. Should any part of the bodywork of the Aston Martin vehicle be perforated, the panel(s) affected by the perforation will be repaired or replaced.

The term 'perforation' means a hole that penetrates through a body panel from the inside.

2 Warranty Period

The period of cover for all types of warranty commences on the day the vehicle is handed over to the first retail customer.

The Vehicle Warranty period of cover is three years with unlimited mileage.

The Anti Perforation Corrosion Warranty period of cover is ten years with unlimited mileage.

3 Who May Repair the Vehicle

Franchise holders or Approved Repairers, who are appointed and receive full technical support from Aston Martin, provide facilities for the servicing and repair of Aston Martin motorcars. Only such Franchise Holders or Approved Repairs will under the terms of this warranty, repair replace or readjust, free of charge to the owner, any part or assemble proved to Aston Martins satisfaction to show a defect in materials or workmanship within the applicable period.

4 Wear and Tear Items

Items that are subject to wear and tear are generally divided into two categories, namely those specified for replacement or adjustment during scheduled maintenance and those that require replacement or adjustment dependent upon conditions of use.

4.1 Scheduled Maintenance Items

The items listed below are covered by the Vehicle Warranty up to the first scheduled change point that replacement or adjustment is required during scheduled maintenance operations. The customer literature supplied with the new Vehicle includes a service book setting out such scheduled maintenance operations.

- Drive Belts
- Spark Plugs
- Oil, air, pollen and fuel filters

 *The period of warranty cover for any item may not exceed the time and distance limitation of the vehicle warranty.*

4.2 Wear and Tear Items

The items listed below are recognised as having a limited service life or are subject to wear or damage. However, these items are covered by the vehicle warranty for up to one year or the first service, which ever occurs first.

- Wiper Blades
- All Light bulbs
HID headlamp bulbs and instrumentation illumination bulbs are covered by the full vehicle warranty.
- Wheel alignment and balancing
- Adjustments, including but not limited to: headlamp and hinged panel adjustments, suspension tightening, steering geometry adjustments, emission and fuel systems checks and park brake cable adjustments
- Remote handset batteries

 *Brake pads, brake discs and other friction related components are not covered when replacement is due to wear and tear, but they are covered against manufacturing defects (whether in material or workmanship) for the duration of the Vehicle Warranty.*

4.3 Consumables

Replacement or top up of consumable fluids, e.g. oils, antifreeze, brake fluid, windscreen wash solution and refrigerant, will only be covered when they are used as part of a warranty repair.

5 What is Not Covered

5.1 Vehicle Warranty

Aston Martin is **not** responsible for any repair or replacement that is required as a direct result of:

- Normal wear and tear
- Failure to properly maintain the vehicle in accordance with Aston Martin's maintenance schedules and service instructions
- Failure to use Aston Martin specified parts or fluids during a warranty repair (or parts of equivalent quality during a retail repair)
- Damage resulting from neglect, accident, flooding or improper use
- Any modification of the vehicle or parts which is not authorised by Aston Martin, including any engine performance enhancement modifications
- Refilling or topping up with incorrect fuel, e.g. diesel instead of petrol
- Use of bio ethanol alternative fuels
- Defects caused as a result of the vehicle being used in motor sport or track events or for any other purpose other than normal private or commercial use

- Any vehicle that has had its vehicle identification number altered or removed, or on which the odometer reading has been unlawfully altered

5.2 Paint Surface and Corrosion Protection

Aston Martin is not responsible for any repair or replacement that is required as a direct result of the following:

- Failure to properly maintain paint and bodywork by regular cleaning in accordance with Aston Martin instructions
- Factors beyond Aston Martin's control, such as environmental hazards (including industrial fallout, storm damage, acid rain) and damage (including stone chips, scratches and use of unsuitable cleaning agents)
- Accident repairs using materials or methods of repair that have not been approved by Aston Martin
- Alterations of the vehicle from Aston Martin's original specification
- Failure to rectify on a timely basis any paint or corrosion damage as recorded in the vehicle documentation by a dealer at the time of the annual inspection

5.3 Other Exclusions

The Aston Martin warranty excludes liability for any lost time, inconvenience, loss of transportation, or any other incidental or consequential damage you (or anyone else) may incur as a result of a defect covered by this warranty.

6 Customer Responsibility

The customer literature will describe the proper care and use of the vehicle. Proper maintenance and use guard against major repair expenses resulting from misuse, neglect or inadequate maintenance, and may help increase the value that the customer may receive when selling the vehicle.

The Customer is responsible to:

- Make sure that the vehicle is maintained in accordance with the vehicle service and maintenance guide published in the customer literature
Failure to perform maintenance promptly and in accordance with Aston Martin's specified service intervals will invalidate warranty coverage on the parts affected.
- The customer is required to take the vehicle to a dealer for any warranty repairs as soon as practicable after a defect is detected
- Make sure that the Service and Maintenance schedule has been stamped by the servicing dealer after the completion of a scheduled service operation
- Make sure that paint and bodywork is maintained by regular cleaning in accordance with the vehicle manufacturer's instructions

- Make sure that the body panels are examined annually by an authorised Aston Martin Dealer and that this inspection is recorded in the Owners Guide

9 Consumer Law

The Warranty is a manufacturer's warranty that supplements and does not affect the Owner's legal rights under the vehicle purchase agreement or under applicable national legislation governing the sale of consumer goods.

Owner Details

Name:

Address:

:

:

:

Post Code:

Signature:

Date:

(Dealer Stamp)

Vehicle Details

Registration Plate No.:

VIN No.:

Engine No.:

Warranty Start Date:

If the vehicle is sold, the benefits of any un-expired portion of the warranties can be transferred to the new owner.

The new owner should complete a 'tear off' sheet (next page) and send the new details to:

Aston Martin Warranty Department

Aston Martin Lagonda Limited

Banbury Road,

Gaydon,

WARWICK,

Warwickshire,

CV35 0DB,

England

Owner Warranty Transfer (3)**Registration plate No.:****VIN No.:****Recorded mileage (km):****Date of Purchase:****Name:****Address:**

:

:

:

Post Code:**Telephone No.:****Signature:****Date:****Owner Warranty Transfer (2)****Registration plate No.:****VIN No.:****Recorded mileage (km):****Date of Purchase:****Name:****Address:**

:

:

:

Post Code:**Telephone No.:****Signature:****Date:****Owner Warranty Transfer (1)****Registration plate No.:****VIN No.:****Recorded mileage (km):****Date of Purchase:****Name:****Address:**

:

:

:

Post Code:**Telephone No.:****Signature:****Date:**



ASTON MARTIN



ASTON MARTIN



ASTON MARTIN

Owner Warranty Transfer (6)**Registration plate No.:****VIN No.:****Recorded mileage (km):****Date of Purchase:****Name:****Address:**

:

:

:

Post Code:**Telephone No.:****Signature:****Date:****Owner Warranty Transfer (5)****Registration plate No.:****VIN No.:****Recorded mileage (km):****Date of Purchase:****Name:****Address:**

:

:

:

Post Code:**Telephone No.:****Signature:****Date:****Owner Warranty Transfer (4)****Registration plate No.:****VIN No.:****Recorded mileage (km):****Date of Purchase:****Name:****Address:**

:

:

:

Post Code:**Telephone No.:****Signature:****Date:**



ASTON MARTIN



ASTON MARTIN



ASTON MARTIN



Aston Martin Assistance

Emergency Service	C.2
Benefits	C.3
Alternative Travel Arrangements	C.4
What To Do In An Emergency	C.6
European Autoroute Restrictions.....	C.7
What is not Covered	C.7
Schedule - Eligible Vehicles	C.11

Emergency Service

As the owner of an Aston Martin vehicle you should enjoy a high standard of trouble free motoring. However, should the unexpected occur, our worldwide Dealer network is there to help you. Details and contact telephone numbers are shown in the Dealer Directory. In the UK and specific countries within Europe, a special additional emergency service, known as '**Aston Martin Emergency Assistance**', has been designed to provide you and your passengers with the help you need quickly and efficiently should your vehicle suffer a Breakdown Incident ¹.

Vehicles Covered

The benefits of Aston Martin Emergency Assistance are applicable to new and / or used Aston Martin vehicles purchased from an authorised Aston Martin Dealer in one of the following countries; Austria, Belgium, Croatia, Czech Republic, Denmark, France, Germany, Italy, Netherlands, Norway, Portugal, Russia, Spain, Sweden, Switzerland and the UK.

At completion of your purchase, your Aston Martin Dealer will register your vehicle for Aston Martin Emergency Assistance. From registration, your vehicle will be entitled to Aston Martin Emergency Assistance (the '**Vehicle**'). For more details of what constitutes an eligible Vehicle, please refer to the Schedule.

An eligible Vehicle is entitled to receive Aston Martin Emergency Assistance for a period of 36 months from the date of registration with the service provider. Owners of eligible Vehicles can also obtain Aston Martin Emergency Assistance when travelling temporarily outside their Country ², within Europe.

Europe is defined as:

Andorra, Austria, Belgium, Bosnia-Herzegovina, Bulgaria, Crete, Croatia, Czech Republic, Denmark, Estonia, Finland, France, Germany, Gibraltar, Greece, Hungary, Italy, Latvia, Liechtenstein, Lithuania, Luxembourg, Monaco, Netherlands, Norway, Poland, Portugal (not Madeira), Republic of Ireland, Romania, Russia, San Marino, Slovakia, Slovenia, Spain (including the Balearic Islands and Canary Islands), Sweden, Switzerland, Turkey (European Part), Ukraine, and Vatican City.

United Kingdom (UK) is defined as:

England, Scotland, Wales, Northern Ireland, Channel Islands and Isle of Man.

¹ A **Breakdown Incident** means an event where an eligible Vehicle is immobilised due to a breakdown in circumstances where it qualifies for Aston Martin Emergency Assistance, including home-starts, fire, broken glass, accident, theft or vandalism. Furthermore, Aston Martin Emergency Assistance covers you in the event of safety-related defects, which render the Vehicle illegal to drive. These defects relate to, for example, failure of the seat belts, windscreen wipers, direction indicators, front and rear lamps.

² '**Country**' means the country in which your Vehicle is registered.

Benefits

The service provider, appointed by Aston Martin to provide the Aston Martin Emergency Assistance services (the 'Service Provider') will provide the following benefits dependent on requirements to entitled Vehicles in both the home Country and Europe as defined.

Roadside Assistance

The Service Provider's Patrol vehicle should promptly arrive with you after your call has been placed. You may also book an appointment for a convenient time.

Aston Martin Emergency Assistance shall provide you with updates on its estimated time of arrival via your preferred communication method.

If following a Breakdown Incident in an area of coverage, your journey cannot be completed, and where the Vehicle cannot be repaired at the roadside, Aston Martin Emergency Assistance shall organise recovery of the Vehicle, including any luggage contained in the Vehicle at the time. Your Vehicle and luggage shall be transported to the nearest Aston Martin Dealer, without distance or financial limitation.

If the Vehicle cannot be repaired at the roadside or at your home address within a reasonable time period (45 minutes), the Service Provider will take you, the Vehicle and your passengers to the nearest Aston Martin Dealer. In the event that you (or your passengers) need to keep an important appointment, you will be taken there before the disabled Vehicle is transported to its required destination.

Should the Breakdown Incident occur outside of workshop hours, Aston Martin Emergency Assistance shall arrange for secure storage of the Vehicle until the next working day. The Vehicle shall arrive at the Dealer on the next working day, within two hours of the Dealership opening.

If the nearest Dealer, to where the eligible Vehicle has been towed, is able to carry out the repairs at its premises, then the Vehicle will be repaired there.

Once the Vehicle is at a Dealership for repair, Aston Martin Emergency Assistance will keep in contact with the Dealer to follow the progress of the repair, and if necessary, arrange any extension of a replacement vehicle with Aston Martin Customer Service.

Home Start

Aston Martin Emergency Assistance will provide all the benefits of Roadside Assistance at the Vehicle's registered address.

Recovery

If Aston Martin Emergency Assistance cannot repair your Vehicle at the roadside, the Service Provider will arrange recovery of you and your Vehicle to the nearest Aston Martin Dealer.

If your Vehicle has been involved in an accident and has gone off the road and needs to be salvaged before towing, Aston Martin Emergency Assistance will charge you for services on a 'Pay for Use' basis and you may be able to claim these back from your insurance company.

You will be covered for costs of recovery and towing (including any handling fee) but you may be charged for any costs incurred if the Vehicle is, for example, disabled by floods or snow-affected roads, is embedded in sand or mud, or is not easily accessible.

Relay Plus

If your Vehicle cannot be repaired and / or recovery is initiated to an Aston Martin Dealer, the Service Provider will provide alternative travel options for you. You will be entitled to receive one of the following additional services:

a) A replacement vehicle for up to two working days in your Country, or 14 days if the Breakdown Incident occurs outside your Country (a collection and delivery service, or equivalent, is available from chosen suppliers subject to availability and supplier's terms and conditions);

b) Onward transportation; or

c) Overnight accommodation.

Vehicle Collection Following Repair

Following repairs organised by Aston Martin Emergency Assistance, the cost of a first class rail ticket or (if rail transport would normally exceed six hours) a business class air ticket will be met to permit you or a person you designate to collect the repaired Vehicle.

Alternatively, arrangements can be made for your Vehicle to be returned to your home or business address, whichever is the nearest to the repairing Dealer. Alternative addresses closer to the repairing Dealer may also be considered.

Alternative Travel Arrangements

If the Service Provider estimates that the repairs to your Vehicle will take more than eight hours, the Aston Martin Emergency Assistance will cover your reasonable costs for alternative necessary travel, including for members of your party.

Reasonable additional expenses shall be covered for one or a combination of the following:

- Replacement vehicle costs to a maximum of two working days in your Country and up to 14 days outside your Country
- Air fares (business class ticket)
- Rail fares (first class ticket)
- Local taxi fares
- Any other transport equivalent to first class rail fares

Replacement Vehicle

If following a Breakdown Incident:

- Your Vehicle is immobilised
- Roadside repairs are unsuccessful
- If repair of the Vehicle is not possible within the same day after towing to the Dealer

Aston Martin Emergency Assistance will organise free of charge, a replacement vehicle for you until completion of the repairs. The replacement vehicle will include fully comprehensive insurance ¹, with an option to upgrade to include collision damage waiver.

The loan of this replacement vehicle will not exceed two working days (in your Country) or, if the Breakdown Incident occurred outside your Country, 14 days plus two working days after your return to your home country.

Aston Martin Emergency Assistance aim to make sure that the replacement vehicle is a suitable vehicle for you. A priority for the choice of the replacement vehicle is a hire car of category G or equivalent, where available. Specially adapted replacement vehicles will not be provided.

The replacement vehicle will be delivered to you, where possible, but if you prefer, taxi costs for collecting the replacement vehicle, will be met by Aston Martin Emergency Assistance.

¹ Unless the driver is under 21 years of age, where there may be an additional charge incurred.

You will be responsible for fuelling and basic maintenance of the replacement vehicle, while under their care. You will also be responsible for paying any deposit required by the vehicle Hire Company.

Once the repair on your Vehicle is complete, the replacement vehicle will then either be returned to the vehicle Hire Company or collection will be arranged where possible, at your request.

If the replacement vehicle has been kept beyond the term of the permitted loan period (as noted above), you will be responsible for any additional charges incurred for the extended period. If you cannot fulfil the nominated vehicle Hire terms and conditions, or circumstances prevent you from qualifying to hire the vehicle, and alternative mobility arrangements are more appropriate, then onward travel arrangements or hotel accommodation will be provided instead. The vehicle hire agreement will be between you and the relevant supplier and will be subject to that supplier's Terms and Conditions. These will usually require or include (amongst other things):

- Production of a full driving licence valid at the time of issue of the hire vehicle
- Limits on acceptable endorsements

- Limitations on the availability and, or engine capacity of the replacement vehicle
- A deposit, e.g. for fuel
- Drivers to be aged at least 18 or 21 years depending on Country, and to have held a full driving licence for at least 12 months.

Onward or Home Journey

If following a Breakdown Incident that occurs more than 80 km (50 miles) from your place of residence, your Vehicle cannot be repaired at the roadside on the same day of the Breakdown Incident, Aston Martin Emergency Assistance will cover:

- The costs of the journey from the place of the Breakdown Incident to the nearest Dealer
- The costs of a replacement vehicle as outlined above
- Where necessary, taxi costs for one journey to the nearest accessible train station or airport, for you and your passenger(s)
- Where necessary, the costs of a first class train journey for you and your passenger(s). If the train journey exceeds six hours, the cost of a scheduled flight (Business Class) for you and your passenger(s).

Aston Martin Emergency Assistance will reimburse you for reasonable costs incurred relating to the above, upon receipt of a claim letter from you, detailing the circumstances of the claim, along with receipts for all transport costs claimed. All claim letters must be directed to Aston Martin Emergency Assistance at The AA, Relay Plus Claims, Aston Martin Emergency Assistance, Fanum House, Basingstoke, Hampshire RG21 4EA, United Kingdom. Only costs directly connected with the Breakdown Incident will be covered. The refund process to you shall be managed by Aston Martin Emergency Assistance.

Repaired Vehicle Re-delivery

Aston Martin Emergency Assistance will attempt to contact you within 24 hours of successful repair at the Dealer in order to arrange re-delivery of the repaired Vehicle to either your home or place of work, as you request. Alternative addresses closer to the Repairing Dealer may also be considered.

Hotel

If following a Breakdown Incident that occurs more than 80 km from your place of residence, and your Vehicle cannot be repaired at the roadside on the day of the Breakdown Incident, accommodation costs for you and your passenger(s) shall be covered for the duration of the repair, for up to a maximum of two nights if the Breakdown Incident occurs in your Country, or seven nights if the Breakdown Incident occurs outside your Country. You shall be responsible for any excess costs.

Repatriation of Un-repaired Vehicle from Abroad

If the Vehicle cannot be repaired by Aston Martin Emergency Assistance within an agreed time schedule (three working days), the costs for transporting the Vehicle and its contents from the Dealer to the home Country Dealer, will be covered by Aston Martin Emergency Assistance.

Aston Martin Emergency Assistance shall arrange the safe repatriation of the Vehicle at the least cost, while respecting the need to deliver the Vehicle to the home Dealer within ten consecutive days.

Aston Martin Emergency Assistance will cover the costs for parking the Vehicle, pending repatriation or import. It may be necessary for Aston Martin Emergency Assistance to repatriate a caravan or trailer on tow at the time of the Breakdown Incident together with the Vehicle if the Vehicle cannot be repaired abroad by your return date.

What To Do In An Emergency

Should assistance be required in the unlikely event of a Breakdown Incident, simply contact Aston Martin Emergency Assistance using the relevant telephone number listed below. It is important that you call the appropriate number should you require assistance.

 *It may be helpful to have the relevant telephone numbers entered into your telephone 'phone book'.*

UK: 0800 316 1178 ¹

Europe: 00 800 28 86 28 86 ¹.

Europe: 00 33 472 172 508

Please do not make your own arrangements as Aston Martin Emergency Assistance will be not be able to reimburse you. If you are in a remote location and need assistance, the time taken to receive the assistance may be longer because of distance and local restrictions.

Vehicle Identification and Location

To minimise delay, please have the following information available:

¹. Calls from landlines shall be free. Calls from mobile phones will be charged at standard mobile network rates.

European Autoroute Restrictions

- Your name
- Aston Martin model
- The Vehicle Identification Number (VIN). The last six digits from the VIN label in the corner of the windscreen
- The location of the vehicle
- Vehicle registration number and colour
- Telephone number where you can be contacted
- Description of the concern experienced

If assistance is required on a French Autoroute or on certain Autoroutes in other European countries, you must use the official SOS boxes at the side of the road in order to arrange initial assistance or recovery. You will be connected to the authorised Autoroute Assistance Service because these roads are privatised. Neither Aston Martin Emergency Assistance nor any other assistance organisations are allowed to assist on these roads.

Once your Aston Martin has been recovered from the Autoroute, you should contact Aston Martin Emergency Assistance at the earliest opportunity to make sure that any further assistance arrangements you require can be made on your behalf.

Aston Martin Emergency Assistance will advise you how to reclaim costs incurred for recovery from the Autoroute.

What is not Covered

Aston Martin Emergency Assistance is thorough and comprehensive; however, claims cannot be met as a result of any of the following:

1. Where you, or anyone else acting on your behalf, make repair or service arrangements without authorisation (and a file number) from Aston Martin Emergency Assistance.
2. Where any loss, theft, damage, death, bodily injury, cost or expense that is not directly associated with the incident that caused you to claim, unless expressly stated in this policy
3. If the Breakdown Incident is due to fire, theft, accident or vandalism, your costs will not be covered by Aston Martin Emergency Assistance but should be met by third party insurance covering the incident.
4. Damage or injury intentionally caused by you or resulting from your participation in a criminal offence.
5. If your Vehicle is kept in an un-roadworthy condition or has not been serviced in accordance with the Manufacturer's recommendations.

6. Any costs that would have been payable by you, such as petrol, toll charges, parking fees, cost of meals, drinks, telephone calls and/ or newspapers or any other costs not specifically stated as being covered by Aston Martin Emergency Assistance, which may be incurred by you and/ or the other member(s) of your party as a result of and/ or in connection with the Breakdown Incident.
7. Release fees: Should your Vehicle be stolen and subsequently recovered by the police, you may be asked to pay a release fee before we can remove your Vehicle to an authorised Aston Martin Dealer.
8. Specialist charges: In the event that the use of specialist equipment is required to give assistance when your Vehicle has, for example, gone off the road, is in a ditch, is standing on soft ground, sand, shingle, stuck in water or snow or has been immobilised by the removal of its wheels, we will arrange recovery but you will be responsible for the costs of any specialist equipment required. The costs may be refundable under the terms of your motor insurance policy.
9. Adverse weather conditions: On those occasions when we experience adverse weather conditions, such as high winds, snow, floods, etc., external resources may be stretched and some operations become physically impossible until the weather improves. At such times, our priority is to make sure that you and your passengers are taken to a place of safety and so the recovery of your Vehicle may not be possible until weather conditions permit.
10. Customer induced breakdown incidents are not covered under Aston Martin Emergency Assistance. However, Aston Martin and the Service Provider will, at their sole discretion, assist you if you request it. However we are not obligated to provide assistance and you shall be responsible for any charges resulting from any assistance given caused by a customer induced fault. In such circumstances, a swipe card deposit maybe taken by the Service Provider. Assistance in such circumstances will not include additional benefits (replacement vehicle, onward journey, hotel accommodation). Customer- induced faults may include, for example, the following:
 - Lock-outs / lost keys
 - Broken keys
 - Discharged battery
 - Running out or loss of fuel
 - Use of wrong fuel (no replacement at the location of breakdown, only towing)
 - Tyre damage
 - Road traffic accidents
11. Lockout / lost keys: Whilst we will always try to provide assistance by the most practical method, should you be unable to gain entry to your Vehicle, modern security systems make it extremely difficult for this to be done should spare keys not be available. If a forced entry is required, you will be asked to sign a declaration stating that you have given permission for this to take place and that any costs for resultant damage will be your sole responsibility.
12. Aston Martin Emergency Assistance shall not be required to provide services in the following circumstances:
 - a) in respect of Vehicles not displaying a valid road fund licence;

b)in respect of eligible Vehicles situated on private property (for example garage premises) unless you can establish to the reasonable satisfaction of Aston Martin Emergency Assistance that permission has been given by the relevant owner or occupier;

c)Vehicle servicing or re-assembly where this is required as a result of neglect or unsuccessful work on the Vehicle other than on the part of the Service Provider or its agents;

d)the recovery of any Vehicles bearing trade plates or which Aston Martin Emergency Assistance has reason to believe have just been imported or purchased at auction;

e)the transportation of immobilised Vehicles where Aston Martin Emergency Assistance considers this to be part of a commercial activity;

f)assistance for Vehicles broken down as a result of taking part in any 'Motor Sport Event', including, without limitation, motor racing, rallying, speed or duration tests or practice thereof, trials or time-trials, auto test (other than auto tests performed by the Client using roadworthy, road legal cars on public roads), but excluding 'Concours d'elegance' events, track test days for road-legal Vehicles or rallies held exclusively on open public roads where participants are required to comply with the normal rules of the road (save for Aston Martin organised and controlled track day events);

g)where the police, highways agency and / or other emergency service require that your Vehicle be recovered by a third part

h)where your entitlement to Aston Martin Emergency Assistance lapses or if your Vehicle is no longer considered eligible for Aston Martin Roadside Assistance, the Service Provider may charge you directly for the Services provided. Any such charges will be charged on a 'pay for use' basis and will constitute a direct contract between you and the Service Provider. If it is determined that Aston Martin is at fault for the Vehicle not being recorded as an eligible Vehicle, then Aston Martin shall pay the relevant charges;

l)assistance for routine maintenance and running repairs of the Vehicle such as fixing faulty radios, interior light bulbs and heated rear windows;

j)for transit risk insurance, which Aston Martin Emergency Assistance recommends you take out where a Vehicle is to be repatriated;

k) where locksmiths, body-glass or tyre specialists are required. Aston Martin Emergency Assistance will endeavour to arrange for their assistance on your behalf, however, you will be responsible for the costs of their services. Further, if use of a locksmith or other specialist would, in Aston Martin Emergency Assistance's opinion, mobilise the vehicle, no further service will be given for the breakdown in question

l) the transportation of any animal or pets shall be at the sole discretion of the Service Provider.

13. The Service Provider may charge you directly for:

a) any replacement component, lubricant and / or fuel (the 'Parts') or consumable items supplied (except where Aston Martin has provided or paid for such Parts);

b) any extension of the Services which you are entitled to receive in connection with this Agreement (which shall be performed by the Service Provider (in its absolute discretion) at your request;

c) the use of any specialist lifting or towing assistance needed to recover your Vehicle if your Vehicle has gone off the road, is in a ditch, sunk in soft ground, sand or shingle or when it is stuck in snow or flood water;

d) any additional charges resulting from the failure to carry legal and serviceable spare wheel(s) or tyre(s) in the Vehicle. Aston Martin Emergency Assistance will endeavour to arrange assistance from a third party on your behalf but you will be responsible for the costs of the call out and/ or for any repair;

e) the cost of garage or other labour required to repair the Vehicle, other than that provided by Aston Martin Emergency Assistance at the scene of the Breakdown Incident;

f) any costs of draining or removing fuel, lubricants or other fluids as a result of the introduction of an inappropriate substance;

g) transportation of personal effects, goods, vehicles, boats or other waterborne craft on or in the Vehicle and any trailer or caravan. Aston Martin Emergency Assistance will not consider any claim for loss resulting from damage to / loss of use of these items. Such items remain your responsibility at all times.

14. If following a Breakdown Incident, the Service Provider, its third party garage agent or subcontractor makes a temporary repair to your Vehicle (for these purposes, a temporary repair shall mean temporary repairs of the Vehicle where the underlying cause of the Vehicle's failure is not resolved), then the Service Provider, its third party garage agent or subcontractor shall recommend you to have such temporary repair made good by a Dealer.

Schedule - Eligible Vehicles

New Vehicles

Any Aston Martin vehicle which is sold directly by Aston Martin or a Dealer in the UK or European Territories and which is first registered in the UK or European Territories (as appropriate).

Used Vehicles

Those used vehicles registered in the UK or the European Territories in respect of which an Extended Warranty has been started.

In All Cases

- Maximum Gross Vehicle Weight (including any caravans or trailers being towed at the time of the Breakdown Incident): 3500 Kg
- Maximum Vehicle Length: 5.5 m
- Maximum Vehicle Width (including any caravans or trailers being towed at the time of the Breakdown Incident): 2.3 m
- Maximum Vehicle Height: 3 m

The dimensions detailed above will be calculated taking into account anything attached to the relevant eligible Vehicle at the time of the relevant Breakdown Incident and any trailer or caravan, including but not limited to towing equipment, any carriers or racks (e.g. bike or luggage), or anything else attached to the Vehicle or the carriers / racks.

Vehicles must be built to manufacturer's specifications, display a road fund licence, and where applicable, hold a certificate of roadworthiness.



ASTON MARTIN



ASTON MARTIN



ASTON MARTIN



ASTON MARTIN

Alphabetical Index

A

Accessory Power Sockets	3.23
Adaptive Damping	5.11
Airbags	3.14
Passenger Deactivation Switch	3.17
Alarm	2.10
Movement Sensor	2.10
Reduced Guard	2.11
Tilt Sensor	2.10
Ambient Temperature	4.16
Anti Corrosion Inspection	A.11
Anti-Lock Braking System	5.8
Approach Light	2.9
Aston Martin Assistance	C.1
Aston Martin Tracking	2.2
Aston Martin Warranty	B.1
Audio	8.1
Battery Protection Mode	8.5
Essentials	8.2

Automatic Lock	2.9
Automatic Transmission	5.3
Fault Conditions	5.6
Parklock Override	11.16
Sport Mode	5.6
Touchtronic Mode	5.5

B

Battery	
Maintenance	11.19
Protection Mode	8.5
Battery Charge	11.19
Battery Conditioner	11.19
Battery Disposal	11.18
Battery Protection Mode	11.20
Bonnet Release	11.6
Boot Lamps	11.26
Boot Lid	2.7
Brake Disc Check	A.10
Brake Pad 'Bedding-in'	11.11

Brakes

Anti-Lock Braking System	5.8
Park Brake	5.12

C

Cabin Storage	3.22
Catalytic Converters	5.14
Child Safety	3.15
Child Seats	3.19
Passenger Airbag Deactivation	3.17
Climate Control	
Automatic Operation	6.6
Controls	6.2
Manual Operation	6.7
Operating Tips	6.2
Coat Hooks	3.25
Component Location	1.4
Condensation, Headlamp Units	11.25

Controls	
Centre	4.8
Information and Warning Symbols	4.4
Instrument Cluster	4.3
Stalk	4.11
Controls Overview	4.2
Cruise Control	4.14

D

Dangerous Substances	11.4
Data Recording	1.5
Day Time Running	4.12
Deadlocking	2.8
Defrosting and Demisting	
Automatic	6.6
Manual	6.7
Driving Techniques	5.16
Dynamic Stability Control	5.9

E

Electric Windows	3.24
Emergency Items	11.4
Emotion Control Unit	2.3
External Lamps	11.26

F

Fluid Levels	11.8
Footbrake	5.7
Front Seat Reset	11.28

Fuel

Catalytic Converters	5.14
Fuel Filling	5.12
Fuse Boxes	11.22

G

Garage Door Opener	2.13
Garage Door Opener (Option)	
Operation	2.14
Programming	2.13
Reprogramming	2.15
Rolling Code Synchronisation	2.14

H

Hands-Free Phone	9.1
Connecting a Phone	9.4
Removing a Phone	9.6
Using a Phone	9.7
Headlamp	11.25
Headlamp Adjustment. Tourist,	11.27
Headlamp Condensation	11.25
Homesafe	2.10

I

Ignition Control	4.10
Interior Mirrors	3.7
Internal Lamps	11.27

J

Jump Start From Another Vehicle	11.16
---------------------------------------	-------

L

Lamps	4.12
Boot	11.26
External	11.26
Headlamp	11.25
Internal	11.27
Locking the Vehicle	2.5
Low Outside Temperature Warning	4.7

M

Maintenance	11.1, 11.5
Vehicle Jacking	11.3
Maintenance Items	
Battery Conditioner	11.6
Tool Kit	11.6
Master Lamp	4.12
Master Vehicle Lock	2.6
Memory Seats	3.6

Mirrors

Auto Fold Function (Door Mirrors)	3.9
Door	3.8
Interior	3.7
Power Fold Function (Door Mirrors)	3.9
Reverse Dip Function (Door Mirrors)	3.9

P

Park Brake	5.12
Parking Assist	
Front and Rear	5.14
Rear Only	5.15
Passenger Airbag Deactivation	3.16
Passive Anti-Theft System	2.12
Personalisation	
Security	2.16

R

Reading Lamps	3.25
Replacement of Airbag Units Record	A.13
Replacement of Seat Belt Pre-tensioners Record ...	A.13
Restraints System	3.10
Determining if the System is Operational	3.10

S

Safety Defects - Reporting	1.5
Satellite Navigation	10.1
Find a Location	10.6
Navigation Map	10.10
Navigation System ON and OFF	10.5
Seat Adjustment	3.2
Seat Adjustment - Lightweight Seat	3.4
Seat Adjustment - Sport Seat	3.3
Seat Belts	3.11
Care and Maintenance	11.31
Child	3.13
Seats	
Memory Function	3.6

Security	
Personalisation	2.16
Service Record	A.8
Servicing	A.4
Servicing Precautions	11.3
Specifications	12.1
Brakes	12.4
Bulbs	12.6
Electrics	12.3
Engine	12.2
Exterior Dimensions	12.7
Features	12.8
Fluids and Capacities	12.9
Interior Dimensions	12.7
Steering	12.3
Suspension	12.4
Transmission	12.3
Tyres	12.5
Vehicle Type	12.6
Wheels	12.4
Starting the Engine	5.2
Steering Wheel	3.7

D.4

Storage	3.22
Supplemental Restraints System	3.14
T	
Track Days	5.17
Traction Control	5.10
Trip	4.13
Tyre	4.16
Tyre Sealant Kit	11.14
Tyres	11.12
Winter	11.13
U	
Unlocking the Vehicle	2.4
V	
Vehicle Battery	11.17
Vehicle Cleaning	11.29
Vehicle Identification	1.4
Vehicle Key	2.3
Vehicle Recovery	11.15
Vehicle Storage	11.32

W

Wheel Nut Torque	12.5
Window Reset	11.28
Windscreen Blade Replacement	11.11
Wipers	
Wiper	4.12